

# **Combitherm® Combination Oven/Steamer**



7.14es CombiTouch

## **COMBITOUCH® SERIES**

### **CombiOven and CombiSmoker®**

## **STEP BY STEP COOKING GUIDE AND OPERATION MANUAL**



7.14esG CombiTouch



W164 N9221 Water Street • P.O. Box 450 • Menomonee Falls, Wisconsin 53052-0450 USA  
PHONE: 262.251.3800 • 800.558.8744 USA/CANADA FAX: 262.251.7067 • 800.329.8744 U.S.A. ONLY  
www.alto-shaam.com

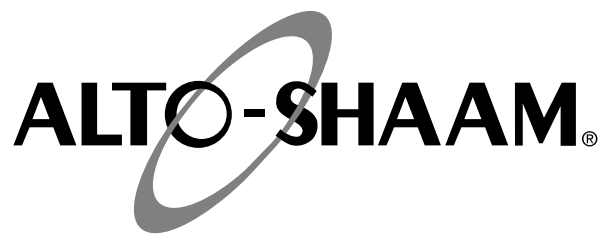

INTRODUCTION . . . . .	1	PREPROGRAMMED RECIPES	
START-UP PROCEDURES . . . . .	2	Using Preprogrammed Recipes . . . . .	23
CONTROL PANEL IDENTIFICATION . . . . .	3-6	Recipe Programming . . . . .	24
FACTORY DEFAULT SETTINGS . . . . .	7	Bakery Recipes . . . . .	25
CHANGE TEMPERATURE SETTING . . . . .	7	Convenience Product Recipes . . . . .	26-27
SAFETY PRECAUTIONS . . . . .	8	Fish & Seafood Recipes . . . . .	28
		Meat Recipes . . . . .	29-30
OPERATION MODES		Miscellaneous Recipes . . . . .	31
Steam . . . . .	9	Poultry Recipes . . . . .	32
Combination . . . . .	11	Vegetable Recipes . . . . .	33-34
Convection . . . . .	13	HACCP ACCESS . . . . .	35
Retherm . . . . .	15	CLEANING & MAINTENANCE	
Core Temperature Probe . . . . .	17	Cleaning Menus . . . . .	36
Calibrating Sous-Vide Probe . . . . .	17	Grease Collection Hook-Up . . . . .	37
Core Temperature - Delta-T . . . . .	18	Preventive Maintenance . . . . .	38
		Food Trolley Cleaning . . . . .	38
AUXILIARY FUNCTIONS		Protecting Stainless Steel Surfaces . . . . .	39
Preheating . . . . .	19	Cleaning Agents . . . . .	39
Gold-n-Brown™ . . . . .	19	Cleaning Materials . . . . .	39
Oven Cool-Down Feature . . . . .	19	Daily Gasket Cleaning . . . . .	40
Reduced Fan Speed . . . . .	20	Probe Usage and Cleaning . . . . .	40
Reduced Power . . . . .	20	Daily Oven Cleaning . . . . .	40
Multi-shelf Timer . . . . .	20	Daily Steam Generator Flush . . . . .	40
Steam Injection . . . . .	20	Daily Prong Cleaning . . . . .	40
Automatic Grease Collection . . . . .	20	Daily Grease Collection Equipment Cleaning . . . . .	40
CombiSmoker® Procedures . . . . .	21-22	Monthly Cleaning . . . . .	40
		Combitherm Oven Cleaner Precautions . . . . .	41
		Steam Generator Flush . . . . .	41
		Regular Decalcification . . . . .	41
		Decalcification . . . . .	42
		TROUBLE SHOOTING	
		Emergency Operation Mode . . . . .	43-44
		Error Codes . . . . .	45-49

## COMBITOUCH® CONTROL

The Combitherm CombiTouch control features a simple, graphics-based control panel that commands all the oven functions. Access up to 250 of your recipes that are identified by your own uploaded pictures. Manual cooking by time and temperature also are easily done with the CombiTouch control.

**Intuitive interface** - The Alto-Shaam CombiTouch offers a simple interface that commands all of the Combitherm's cooking functions. As the name implies, it is fully operable by touch.

**Graphic controls** - The highly visual graphic-based control overcomes language barriers while the simple, logical procedures ensure that correct steps are followed every time.

**An excellent memory** - Access up to 250 of your recipes that are identified by your own uploaded pictures. The Combitherm with CombiTouch also comes standard with more than 100 pre-programmed recipes and photos, covering most commonly prepared food items.

**Powerful tool** - The CombiTouch control plays an important part in our continuous improvement process. New features and abilities can be uploaded to your oven as they become available. Simply call our Service Department for assistance.

## ECOSMART® TECHNOLOGY



The Alto-Shaam CombiTouch Combitherm combination oven/steamer employs Ecosmart operating efficiencies in the design and application of all operating and programming functions.

Ecosmart operational characteristics include the use of a water barrier to close the oven compartment to the outside air. While maintaining a non-pressurized atmosphere, the primary purpose of the Ecosmart system is to prevent the steam and heat generated within the oven compartment from freely escaping to the outside.

**Standard HACCP** - The Combitherm with CombiTouch includes a standard downloadable HACCP function.

**Six levels of Gold-n-Brown™** - Six precise and consistent browning levels are available with the CombiTouch. The exclusive Gold-n-Brown feature gives the operator the ability to achieve the ideal cooking environment for the ideal finish.

**Superior baking** - The new two-speed reversing fan provides excellent and consistent baking results. A moisture injection feature provides perfect sheen and crust on breads and pastry items.

**Multi-shelf timers** - Track cooking time of either 7 or 10 different food items (depending on oven size) in the same oven with multi-shelf timers. Time is tracked in minutes and seconds.

**On-board diagnostics** - The CombiTouch system includes on-board diagnostic functionality with results displayed right on the touch screen.

**Reduced energy setting** - CombiTouch features an interactive control display with reduced energy setting.



STEAM MODE



COMBINATION MODE



CONVECTION MODE



RETERM MODE

# OPERATING INSTRUCTIONS

## START-UP PROCEDURES

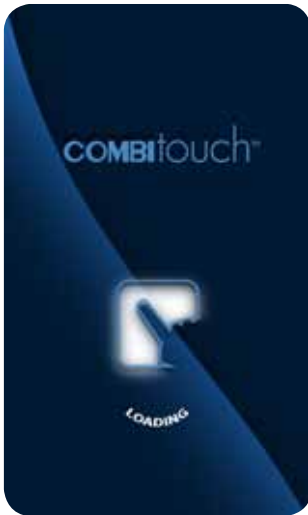

Illustration 1



Illustration 2

When the oven is powered on, the CombiTouch screen illuminates. "Loading" indicates that the software is booting up. The screen will also indicate what level of progress has been made as the software becomes fully operational. (see illustrations 1 & 2 at left)





Illustration 3



Illustration 4

If, for any reason, the oven is turned off or loses power during this start-up process, the operator will be prompted to calibrate the CombiTouch screen when the oven is next powered up. (see illustration 3 at left)

 **Return to Recipe Menu** - Press the red arrow if the CombiTouch screen *does not* need to be calibrated.

 **Begin Calibration Process** - Press the green check mark if the CombiTouch screen *does* need to be calibrated. The screen will switch to a grey background. (see illustration 4 at left) A crosshairs icon will appear. The operator should touch the center intersection. This prompt and required action will be repeated several times in different areas of the touchscreen. When complete, the operator will be returned to the recipe menu.

# OPERATING INSTRUCTIONS

## CONTROL PANEL IDENTIFICATION

### RECIPE MENU

When the oven is powered on, the Recipe Menu is the first screen you will see. This allows quick access to begin the cooking process. As a first time user, you may want to personalize your CombiOven to reflect the settings you are most comfortable with.





 **Return to Previous Screen** - Press the red arrow to access the Main Menu screen.



### MAIN MENU SCREEN





- 1 CLEANING MODE
- 2 DOWNLOAD/UPLOAD FILES
- 3 SETTINGS
- 4 SERVICE MODE (PASSWORD PROTECTED)

-  **Cleaning Mode**  
Four (4) cleaning levels are available: rinse, light, normal, and heavy-duty cleaning.
-  **Download/Upload Files**  
Download all preprogrammed recipes (factory default and user-programmed) and photos to a USB memory stick. *See below for more information.*
-  **Settings and HACCP Access**  
Change factory default settings. *See page 7 for more information.*
-  **Service Mode (password protected)**  
This mode is only available to qualified service technicians.

### UPLOAD/DOWNLOAD SCREEN



-  **Download Recipes**  
Copy *all* recipes from USB memory stick to oven. This will replace and overwrite existing recipes.
-  **Upload Recipes**  
Copy *all* recipes from oven to USB memory stick.
-  **Add All Recipes**  
Copy *all* recipes from USB memory stick to the oven. This will add the recipes to the beginning of the existing recipe list.
-  **Delete Photos on Oven**  
Delete specific photo files used in the programmed recipes on oven

# OPERATING INSTRUCTIONS

## CONTROL PANEL IDENTIFICATION SETTINGS SCREEN

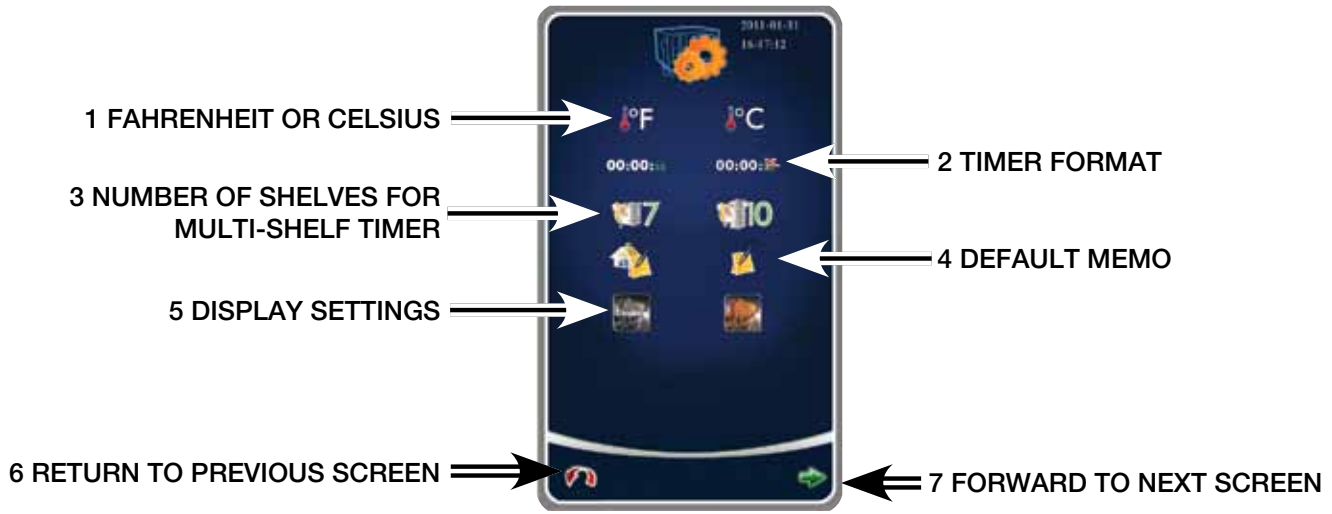

- 1. Fahrenheit or Celsius Function** - Choose temperature format. (See page 7 for more information.)
- 2. Timer Format** - Display time as HOURS:MINUTES:SECONDS or HOURS:MINUTES.
- 3. Multi-shelf Timer Number of Shelves** - Choose the default number shelves in the oven to be used by the multi-shelf timer.
- 4. Default Memo** - Left icon reverts time/temperature setting to factory defaults when switching modes. Right icon allows you to keep the last user setting.
- 5. Display Settings** - Choose to display text or image assigned to a recipe.
- 6. Return to Previous Screen** - Return to previous screen when finished adjusting settings.
- 7. Forward to Next Screen** - Advance to next screen to review additional settings.
- 8. Sound/Alarm Settings** - Change alarm sounds and volume.
- 9. Touchscreen Brightness** - Adjust brightness of Touchscreen.
- 10. Lock/Unlock Recipes** - Password protect preprogrammed recipes.
- 11. Set/Change Date & Time** - Set or change oven time and date settings.
- 12. HACCP Data** - Review data collected or download data to a USB drive.
- 13. Keyboard Letter Choice** - Set or change keyboard letters to English or Russian. After the change has been made, the oven must be turned off. Allow the oven to completely shut down before turning the oven back on again, and then
- 14. Update Software** - Update control software with data loaded onto a USB drive.



# OPERATING INSTRUCTIONS



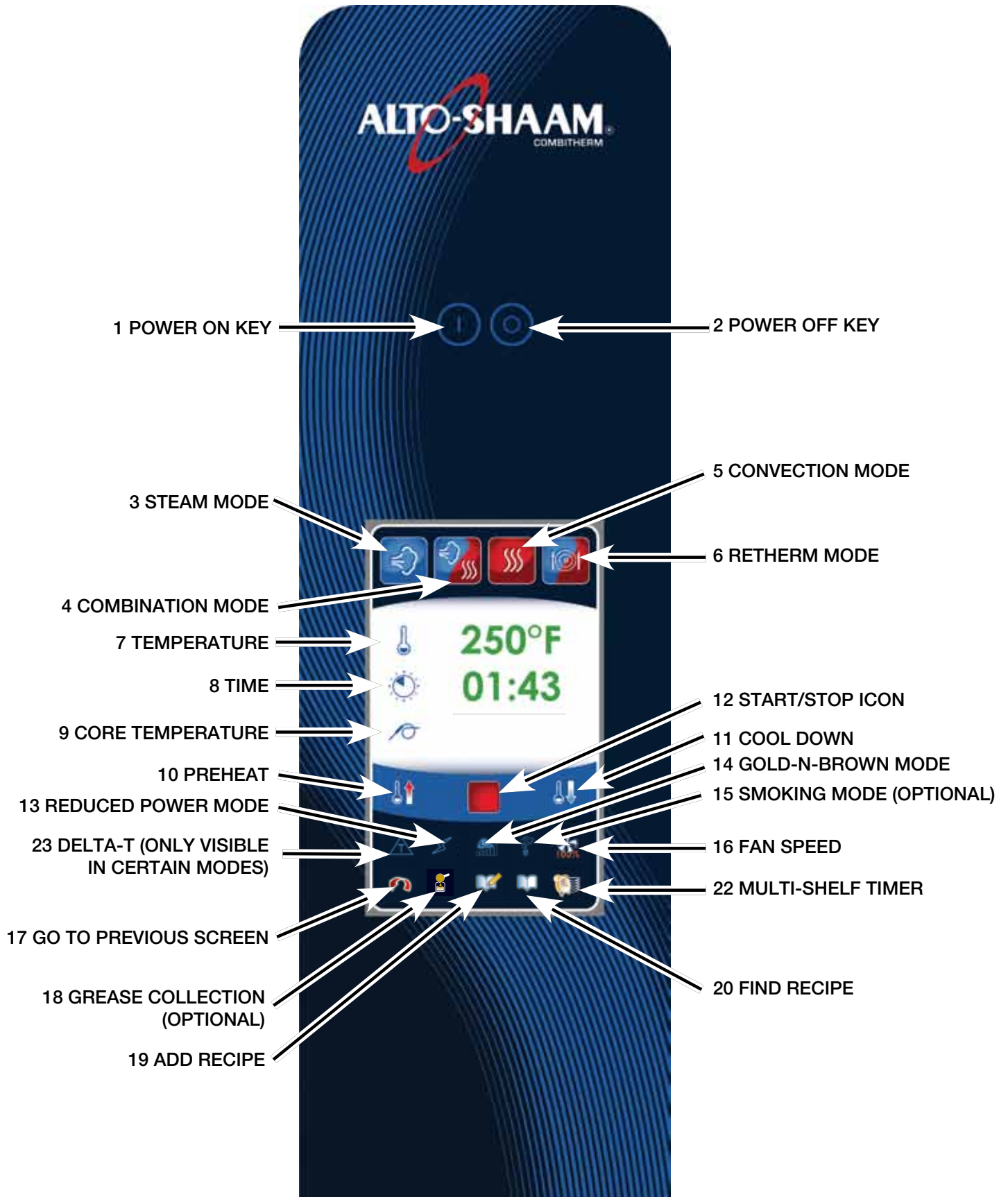







## CONTROL PANEL IDENTIFICATION





# OPERATING INSTRUCTIONS









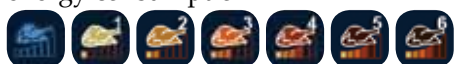

## CONTROL PANEL IDENTIFICATION

### MAIN MENU ICONS

-  **Power ON key**  
Activates power to the oven and automatically fills the steam generator equipped models with water that will heat to a stand-by mode temperature of 188°F (77°C).
-  **Power OFF key**  
Press once to initiate power shut down sequence to the oven. *Note:* Oven will not shut down during a cooking cycle. You may need to press harder due to the material thickness. Firmly press and hold the OFF key for 10 seconds to power down the oven *ONLY IF* the control has locked and is unresponsive.
-  **Steam Mode**  
The oven will operate in the steam mode at a temperature range of 85°F to 250°F (30°C to 121°C).
  - Automatic steaming at 212°F (100°C) factory-set default.
  - Quick steaming between 213°F and 250°F (101°C and 121°C).
  - Low temperature steaming between 85°F and 211°F (29°C and 99°C).
-  **Combination Mode**  
Selection key for cooking with a combination of steam and convection heat. Can be set between 212°F to 485°F (100°C and 252°C).
-  **Convection Mode**  
Selection key for convection cooking without steam at a temperature range of 85°F to 485°F (29°C to 252°C).
-  **Retherm Mode**  
Food rethermalization or reheating mode will operate with automatic steam injection at a temperature range of 245°F to 320°F (120°C to 160°C).
-  **Temperature**  
Used to set the required cooking temperature, to recall the set cooking temperature, or to check the actual oven temperature.
-  **Time**  
Used to set the required cooking time or recall the set cooking time.
-  **Core Temperature**  
Used to set the required internal product temperature, to recall the internal product temperature set by the operator, or to display the current internal temperature of the product.
-  **Preheat Mode**  
Preheats the oven cavity to a temperature set by user.

-  **Cool Down Mode**  
Lowers temperature of the oven cavity at an accelerated pace to temperature set by user.
-  **Start/Stop**  
Initiates all cooking mode functions and programmed procedures stored in memory. Stops an activated cooking mode or programmed procedure currently in progress.

### AUXILIARY FUNCTION ICONS

-  **Reduced Power Mode**  
Used to reduce kitchen power peaks and energy consumption.
-  **Gold-N-Brown Mode**  
This indicator will illuminate when the browning function is set by the operator in a timed or programmed cooking cycle in any mode. Level 1 provides least amount of browning, level 6 the most.
-  **Smoking Mode (optional)**  
This indicator will illuminate when the smoking function is set by the operator in a timer, probe or programmed cooking cycle in either convection mode or combination mode.
-  **Fan Speed**  
This indicator will illuminate whenever the operator sets a reduced fan speed to protect products affected by high-velocity air movement.
-  **Return to Previous Menu**
-  **Automatic Grease Collection (optional)**  
Separates grease from water, then pumps grease and by-products directly into a grease collection container.
-  **Add Recipe**  
Used to create, change, duplicate, and delete programmed menus.
-  **Find Recipe**  
Access a menu list of all stored cooking programs.
-  **Multi-shelf Timer**  
Use separate timers for one or more shelves in the oven compartment (only visible in time mode).
-  **Steam Injection (not shown on illustration)**  
Press to add moisture in any cooking mode. Steam will inject into the cavity as long as the icon is touched.
-  **Delta-T Core Temperature (only visible in certain modes)** Cook by probe. Mode automatically adjusts cooking temperature in proportion to the internal temperature of the product.









# OPERATING INSTRUCTIONS

## COMBITOUCH FACTORY DEFAULT SETTINGS

COOKING MODE	OVEN TEMPERATURE	CORE TEMPERATURE	COOKING TIME
Steam	212°F (100°C)	160°F (70°C)	25 minutes
Combination Steam	350°F (175°C)	160°F (70°C)	70 minutes
Convection	350°F (175°C)	160°F (70°C)	30 minutes
Retherm	275°F (135°C)	160°F (70°C)	5 minutes

## CHANGE THE TEMPERATURE SCALE

-  Press Oven Power switch ON.  
The Recipe Menu screen will load.
-  Press the red arrow key to access the Main Menu screen.
-  Press the Settings key.
-  Press Fahrenheit or Celsius key.  
Choose temperature format you prefer.
-  Press the red arrow key to access the Main Menu screen.
-  Press Oven Power switch OFF.

# OPERATING INSTRUCTIONS

## IMPORTANT SAFETY PRECAUTIONS



**NOTE:** Automatic steam venting is a standard safety feature built into all Combitherm oven models. This feature vents all steam from the oven compartment immediately before cooking time expires or set probe temperature is reached.

This function is provided in all programmed and timed production when operating in any Steam, Combination, Convection, and Retherm cooking mode. Automatic steam venting does not function if the oven door is opened before time expires or when the oven has been set to continuous operation.

**NOTE:** Use authorized combitherm oven cleaner only. unauthorized cleaning agents may discolor or harm interior surfaces of the oven. Read and understand label and material safety data sheet before using the oven cleaner.

### FOR OPERATOR SAFETY

NOTE AND OBSERVE ALL SAFETY PRECAUTIONS LOCATED THROUGHOUT THIS GUIDE

<b>DANGER</b>	
	AT NO TIME SHOULD THE INTERIOR OR EXTERIOR BE STEAM CLEANED, HOSED DOWN, OR FLOODED WITH WATER OR LIQUID SOLUTION OF ANY KIND. DO NOT USE WATER JET TO CLEAN.
	<b>SEVERE DAMAGE OR ELECTRICAL HAZARD COULD RESULT.</b> WARRANTY BECOMES VOID IF APPLIANCE IS FLOODED

<b>CAUTION</b>	
	METAL PARTS OF THIS EQUIPMENT BECOME EXTREMELY HOT WHEN IN OPERATION. TO AVOID BURNS, ALWAYS USE HAND PROTECTION WHEN OPERATING THIS APPLIANCE.

<b>CAUTION</b>	
<b>DO NOT USE THE ATTACHED HAND-HELD HOSE TO SPRAY ANYTHING OTHER THAN THE INTERIOR OF THE COMBITHERM OVEN COMPARTMENT.</b>	
<b>DO NOT USE THE SPRAY HOSE ON THE SURFACE OF A HOT COOKING COMPARTMENT. ALLOW THE OVEN TO COOL TO A MINIMUM OF 150°F (66°C).</b>	

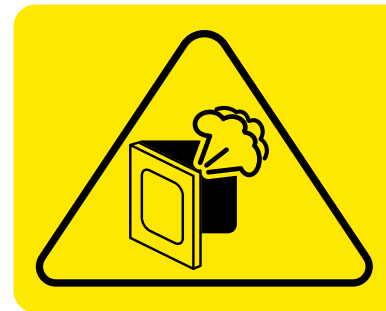

<b>WARNING</b>	
<b>HOT STEAM CAUSES BURNS</b>	
ROTATE THE DOOR HANDLE TO THE FIRST OPEN ROTATION POSITION ONLY. WAIT UNTIL THE STEAM IS VENTED BEFORE FULLY OPENING THE DOOR.	



<b>WARNING</b>	
<b>DO NOT HANDLE PANS CONTAINING LIQUID OR SEMILIQUID PRODUCTS POSITIONED ABOVE THE EYE LEVEL OF THE OPERATOR. SUCH PRODUCTS CAN SCALD AND CAUSE SERIOUS INJURY.</b>	

# OPERATING INSTRUCTIONS



## STEAM MODE

The Steam mode provides the operator with the ability to steam, poach, or blanch. This mode will automatically steam at the boiling point of water; quick-steam above the boiling point for faster cooking results; or low temperature steam, below the boiling point, for more delicate products such as pâté, mousse, seafood, or custard.



PRESS ON BUTTON TO POWER OVEN ON.



PRESS THE STEAM MODE ICON.



PRESS THE START ICON TO STEAM AT THE DISPLAYED SETTINGS.

### TO CHANGE THE DISPLAYED SETTINGS:



TOUCH THE DISPLAYED TEMPERATURE.

The cooking temperature will appear at the top of the temperature selection window. Type in desired temperature or use up and down arrows to adjust temperature. When finished, touch the green check mark key  to confirm change.

- Automatic Steaming 212°F (100°C)
- Quick Steaming 213°F to 250°F (101°C to 121°C)
- Low Temperature Steaming 85°F to 211°F (29°C to 99°C)

### TO COOK BY TIME:



TOUCH THE DISPLAYED TIME.

The cooking time will appear at the top the time selection window. Type in desired time period or use up and down arrows to adjust time. When finished, touch the green check mark key to confirm change.

Or, to set Continuous Operation mode, press the --:-- icon and  touch the green check mark key to confirm.

### TO COOK BY PRODUCT CORE TEMPERATURE:





TOUCH THE PROBE ICON.

The previously set core temperature or oven control default setting will appear highlighted within the oven display. Touch the displayed core temperature. The internal product core temperature will appear at the top of the temperature selection window. Type in desired internal product core temperature or use up and down arrows to adjust temperature. When finished, touch the green check mark key  to confirm change.

Attach removable probe before activating core temperature function, and insert into product.



PRESS THE GREEN START ARROW ICON TO BEGIN COOKING IN STEAM MODE.

- The cavity set-temperature will appear in the display.
- If cooking by probe, the actual internal product temperature will appear next to the  icon during operation. To change the set value for core temperature, press the temperature next to the  icon and make changes as required.

When the cooking time has expired or the desired core temperature has been reached, an alarm will sound indicating the end of the operating mode.

- To stop the buzzer, press the red stop icon  or open the oven door.



TO STOP COOKING PROGRAM AT ANY TIME, PRESS RED STOP ICON.

# OPERATING INSTRUCTIONS



## STEAM MODE CHEF OPERATING TIPS

This mode will steam a full or partial load of a single product, or multiple products without transfer of flavors. When steaming multiple products, however, individual product cooking times must be taken into consideration.

The non-pressurized atmosphere of the Combitherm also provides the ability to open the door during the steam mode in order to monitor products more closely throughout the steaming process.

### STEAM

Perforated, 2-1/2" deep pans (65mm) are particularly suitable for use in this program mode. These pans will provide a shorter cooking time and will prevent product over-cooking at the bottom of the pan.

---

Separate ice-encrusted vegetables before steaming to ensure even cooking.

---

A variety of products can be steamed at the same time but attention must be paid to the different cooking times required for each food product.

---

### HIGH TEMP STEAM

High temperature steaming is suitable for hearty, root-type vegetables such as potatoes, turnips, carrots, and cabbage.

---

High temperature steaming provides a cooking time which is approximately 10-percent shorter than the regular steam mode temperature of 212°F (100°C).

---

Set the steam cooking temperature between 221°F (105°C) and 230°F (110°C) for small loads and between 230°F (110°C) and 250°F (121°C) for full loads.

---

### LOW TEMP STEAM

The low temperature steam mode will function whenever the oven compartment temperature is below 212°F (100°C).

---

It will take longer to steam products using the low temperature steam mode.

---

Steaming sausages in low temperature steam prevents cracked or peeling skins.

---

Use low temperature steam for delicate foods such as shrimp, fish, seafood, and crème caramel.

---

For best results, low temperature steam all delicate food items at a temperature of 210°F (99°C) or below.

---

# OPERATING INSTRUCTIONS



## COMBINATION MODE

The Combination mode will prove to be the most versatile and widely used mode the Combitherm oven has to offer. It will produce the best possible results on the widest variety of products — all within the shortest period of time. The unique control function of this mode enables the operator to roast or bake with a combination of steam and convection heat. In addition to shorter cooking times, this combination of steam and heat offers less product shrinkage and more moisture retention than obtained in a standard convection oven.



PRESS ON BUTTON TO POWER OVEN ON.



PRESS THE COMBINATION MODE ICON.

The last set values or oven control default setting for temperature and time will appear in the display.



PRESS THE START ICON TO COOK AT THE DISPLAYED SETTINGS.

### TO CHANGE THE DISPLAYED SETTINGS:



TOUCH THE DISPLAYED TEMPERATURE.

The cooking temperature will appear at the top of the temperature selection window. Type in desired temperature or use up and down arrows to adjust temperature. When finished, touch the green check mark key  to confirm change.

- Cooking temperature range: 212 to 485 °F (100 to 252°C)

### TO COOK BY TIME:



TOUCH THE DISPLAYED TIME.

The cooking time will appear at the top the time selection window. Type in desired time period or use up and down arrows to adjust time. When finished, touch the green check mark key  to confirm change.

Or, to set Continuous Operation mode, press the --:-- icon and touch the green check mark key to confirm.

### TO COOK BY PRODUCT CORE TEMPERATURE:





TOUCH THE PROBE ICON.

The previously set core temperature or oven control default setting will appear highlighted within the oven display. Touch the displayed core temperature. The internal product core temperature will appear at the top of the temperature selection window. Type in desired internal product core temperature or use up and down arrows to adjust temperature. When finished, touch the green check mark key  to confirm change.

Attach removable probe before activating core temperature function, and insert into product.



PRESS THE GREEN START ARROW ICON TO BEGIN COOKING IN COMBINATION MODE.

- The temperature and remaining cooking time will appear in the display.
- If cooking by probe, the actual internal product temperature will appear next to the  icon during operation. To change the set value for core temperature, press the temperature next to the  icon and make changes as required.



PRESS FOR STEAM INJECTION AT ANY TIME DURING COOKING. Steam will inject into the cavity as long as the icon is touched.

When the cooking time has expired or the operator set internal temperature has been reached, an alarm will sound indicating the end of the operating mode.

- To stop the buzzer, press the red stop icon  or open the oven door.



TO STOP COOKING PROGRAM AT ANY TIME, PRESS RED STOP ICON.

# OPERATING INSTRUCTIONS



## COMBINATION MODE CHEF OPERATING TIPS

The Combination mode injects the optimum amount of steam automatically. There is no need to select moisture levels. Foods do not dry out. Flavors are retained with no transfer of flavors when mixing product loads.

---

Due to automatic steam adjustment, the door can be opened at any time during a cooking operation. Be certain to observe the safety warning when opening the oven door.

---

The Combination mode is particularly efficient when used for baking, broiling, grilling, stewing, braising, and roasting.

---

When using the Combination mode, cooking temperatures can be reduced 10- to 20-percent below the temperatures used for conventional cooking methods.

---

Cooking time will be reduced approximately 40-percent when cooking at the same temperature used for convection oven cooking and up to 50- to 60-percent less time when cooking at the same temperature used for a conventional oven.

---

Food browning in the Combitherm begins at a cooking temperature of approximately 250°F (120°C).

---

A higher cooking temperature results in heavier browning but also results in greater product weight loss. To achieve additional browning use the Moisture Vent Key or set Gold-n-Brown into the product procedure. Gold-n-Brown is particularly useful for adding color to high moisture products such as chicken and other poultry items or for additional browning of full loads and other moist products.

---

The Combination mode provides even browning without the necessity to turn the pans.

---

For more even cooking, do not cook in pans deeper than 4" (100mm).

---

# OPERATING INSTRUCTIONS



## CONVECTION MODE

The Convection mode operates with hot circulated air within a temperature range of 85° to 485°F (29 to 252°C). For many applications, better results may be achieved with the Combination mode; therefore, the operator may want to consider using the Convection mode on a more limited basis.



PRESS ON BUTTON TO POWER OVEN ON.



PRESS THE CONVECTION MODE ICON.

The last set values or oven control default setting for temperature and time will appear in the display.



PRESS THE START ICON TO COOK AT THE DISPLAYED SETTINGS.

### TO CHANGE THE DISPLAYED SETTINGS:



TOUCH THE DISPLAYED TEMPERATURE.

The cooking temperature will appear at the top of the temperature selection window. Type in desired temperature or use up and down arrows to adjust temperature. When finished, touch the green check mark key  to confirm change.

- Cooking temperature range: 85 to 485 °F (29 to 252°C)

### TO COOK BY TIME:



TOUCH THE DISPLAYED TIME.

The cooking time will appear at the top the time selection window. Type in desired time period or use up and down arrows to adjust time. When finished, touch the green check mark key  to confirm change.

Or, to set Continuous Operation mode, press the --:-- icon and touch the green check mark key to confirm.

### TO COOK BY PRODUCT CORE TEMPERATURE:





TOUCH THE PROBE ICON.

The previously set core temperature or oven control default setting will appear highlighted within the oven display. Touch the displayed core temperature. The internal product core temperature will appear at the top of the temperature selection window. Type in desired internal product core temperature or use up and down arrows to adjust temperature. When finished, touch the green check mark key  to confirm change.

Attach removable probe before activating core temperature function, and insert into product.



PRESS THE GREEN START ARROW ICON TO BEGIN COOKING IN COMBINATION MODE.

- The temperature and remaining cooking time will appear in the display.
- If cooking by probe, the actual internal product temperature will appear next to the  icon during operation. To change the set value for core temperature, press the temperature next to the  icon and make changes as required.



PRESS FOR STEAM INJECTION AT ANY TIME DURING COOKING. Steam will inject into the cavity as long as the icon is touched.

When the cooking time has expired or the operator set internal temperature has been reached, an alarm will sound indicating the end of the operating mode.

- To stop the buzzer, press the red stop icon  or open the oven door.



TO STOP COOKING PROGRAM AT ANY TIME, PRESS RED STOP ICON.

# OPERATING INSTRUCTIONS



## CONVECTION MODE CHEF OPERATING TIPS

The Convection Mode can be used to roast or bake products needing very short cooking times or for high moisture products such as muffins, cakes, and cookies, or for browning the surface of the product.

---

The Convection mode works best with foods containing little moisture or for very moist food which require a dryer finished product.

---

For baking, preheat the Combitherm at a temperature of 325°F to 375°F (163°C to 191°C). Once preheated, reset the temperature as required.

---

A higher cooking temperature results in heavier browning but also results in greater product weight loss. To achieve additional browning use the Moisture Vent Key or set the Browning Feature into the product procedure.

---



# OPERATING INSTRUCTIONS



## RE THERM MODE

The Retherm mode operates with hot circulated air within a temperature range of 245° to 320°F (120° to 160°C).



PRESS ON BUTTON TO POWER OVEN ON.



PRESS THE RETHERM MODE ICON.

The last set values or oven control default setting for temperature and time will appear in the display.



PRESS THE START ICON TO COOK AT THE DISPLAYED SETTINGS.

### TO CHANGE THE DISPLAYED SETTINGS:



TOUCH THE DISPLAYED TEMPERATURE.

The cooking temperature will appear at the top of the temperature selection window. Type in desired temperature or use up and down arrows to adjust temperature. When finished, touch the green check mark key  to confirm change.

- Cooking temperature range: 245 to 320 °F (120 to 160°C)

### TO COOK BY TIME:



TOUCH THE DISPLAYED TIME.

The cooking time will appear at the top the time selection window. Type in desired time period or use up and down arrows to adjust time. When finished, touch the green check mark key  to confirm change.

Or, to set Continuous Operation mode, press the --:-- icon and touch the green check mark key to confirm.

### TO COOK BY PRODUCT CORE TEMPERATURE:





TOUCH THE PROBE ICON.

The previously set core temperature or oven control default setting will appear highlighted within the oven display. Touch the displayed core temperature. The internal product core temperature will appear at the top of the temperature selection window. Type in desired internal product core temperature or use up and down arrows to adjust temperature. When finished, touch the green check mark key  to confirm change.

Attach removable probe before activating core temperature function, and insert into product.



PRESS THE GREEN START ARROW ICON TO BEGIN COOKING IN COMBINATION MODE.

- The temperature and remaining cooking time will appear in the display.
- If cooking by probe, the actual internal product temperature will appear next to the  icon during operation. To change the set value for core temperature, press the temperature next to the  icon and make changes as required.



PRESS FOR STEAM INJECTION AT ANY TIME DURING COOKING. Steam will inject into the cavity as long as the icon is touched.

When the cooking time has expired or the operator set internal temperature has been reached, an alarm will sound indicating the end of the operating mode.

- To stop the buzzer, press the red stop icon  or open the oven door.



TO STOP COOKING PROGRAM AT ANY TIME, PRESS RED STOP ICON.

# OPERATING INSTRUCTIONS



## RETERM MODE CHEF OPERATING TIPS

Since plated meals consist of dissimilar products, there are several important factors to consider in order to produce the finest results. Product density (compactness), thickness, quantity of product on each plate, and quantity of plates all relate to the length of time necessary to reheat. Again, experience is the best method to determine reheating time. Once the time has been determined and recorded for a specific meal, the results will be consistent for future reheating times.

### HELPFUL HINTS FOR REHEATING ON THE PLATE

- ALL FOOD COMPONENTS ON THE PLATE SHOULD BE OF SIMILAR DENSITIES.
- ALL FOOD COMPONENTS ON THE PLATE SHOULD BE SIMILAR IN THICKNESS.
- ARRANGE ALL FOOD COMPONENTS EVENLY ON THE PLATE.
- AVOID EXCESSIVE OVERLAPPING OF PRODUCT.
- SAUCES MUST BE HEATED AND ADDED TO PRODUCT AFTER REHEATING.
- A MIXED VARIETY OF MEALS CAN BE REHEATED AT THE SAME TIME.

### À LA CARTE RETHERMALIZATION

À la carte rethermalization is designed to take a single plate from a refrigerated temperature to serving temperature for immediate service. Plates are prepared in advance, covered, and refrigerated. Preheat the Combitherm oven. Remove plate from refrigeration and place in the oven at 275°F (135°C) for an uncovered plate or 300°F (150°C) for a covered plate. Plates with meat components will take more time than plates containing all vegetable components. Follow internal temperature requirements for reheating and allow for override time. After reheating, remove the plate from the oven, add any sauces, garnish, and serve. This process can be repeated as required.

For the most efficient continuous service, it is suggested that the Combitherm oven be dedicated to the rethermalization process during serving hours.

### BANQUET RETHERMALIZATION

Banquet rethermalization is designed for high volume, full or partial load (multiple plate) reheating.

Plates are assembled in advance, covered, and refrigerated or loaded on the roll-in cart and refrigerated. Preheat the Combitherm oven at 275°F (135°C) for uncovered plates or 300°F (150°C) for covered plates. Remove plates or the roll-in cart from refrigeration, load in the oven and set timer as required. Follow internal temperature requirements for reheating and allow for override time. Remove the plates or roll-in cart from the Combitherm.

Placing our thermal blanket cover over the roll-in cart keeps food hot for 20 to 40 minutes, depending on the type of food, retherm temperature, and environmental factors. For longer holding times, roll the cart into the CombiMate™ companion holding cabinet.

### REETHERMALIZING PREFABRICATED AND VACUUM-PACKED FROZEN FOODS

For bulk product rethermalization, completely defrost product bags in walk-in cooler. **DO NOT REMOVE PRODUCT FROM THE BAG.** Load thawed bags in preheated oven and rethermalize in the Low Temperature Steam mode until the required internal temperature is reached. Place rethermalized bags in a preheated holding cabinet set at 140° to 165°F (60° to 74°C) until ready for service.

For large volume on-the-plate regeneration, defrost bags in walk-in cooler. Open bags and plate per menu requirements in a (maximum) 55°F (13°C) refrigerated room. Place on Alto-Shaam roll-in cart (trolley), and roll into Combitherm oven preheated at 275°F (135°C).

Regenerate in the Convection mode for 3 to 5 minutes. Switch to the Retherm mode for an additional 3 minutes or more if required. Placing our thermal blanket cover over the roll-in cart keeps food hot for 20 to 40 minutes, depending on the type of food, retherm temperature, and environmental factors. For longer holding times, roll the cart into the CombiMate™ companion holding cabinet.

**PLATE COVERS MUST BE USED FOR ON-THE-PLATE REGENERATION.**

# OPERATING INSTRUCTIONS

## CORE TEMPERATURE PROBE MODE

As an alternative to timer operation, the Core Temperature Probe mode can be used in conjunction with any program mode to cook by sensing internal product temperature using the included probe. For a more accurate internal temperature, an optional, specialized, Combitherm product probe senses temperature from four strategic points and displays a temperature average.



PRESS ON BUTTON TO POWER OVEN ON.

ATTACH REMOVABLE PROBE BEFORE ACTIVATING CORE TEMPERATURE FUNCTION, AND INSERT INTO PRODUCT.

The probe must be inserted so that the tip is positioned in the center of the food mass. For liquid or semi-liquid foods, suspend the probe in the center of the product and secure the probe wire to the edge of the container.

PRESS THE REQUIRED COOKING MODE ICON. The last set values or oven control default setting for temperature and time will appear in the display.



PRESS THE START ICON TO COOK AT THE DISPLAYED SETTINGS, OR



TOUCH THE DISPLAYED TEMPERATURE.



The cooking temperature will appear at the top of the temperature selection window. Type in desired temperature or use up and down arrows to adjust temperature. When finished, touch the green check mark key  to confirm change.

 TOUCH THE PROBE ICON.

The previously set core temperature or default setting will appear highlighted within the oven display. Touch the displayed core temperature. The internal product core temperature will appear at the top of the temperature selection window. Type in desired internal product core temperature or use up and down arrows to adjust temperature. When finished, touch the green check mark key  to confirm change.



PRESS THE GREEN START ARROW ICON TO BEGIN COOKING.

- The actual internal product temperature will appear next to the  icon during operation. To change the set value for core temperature, press the temperature next to the  icon and make changes as required.



PRESS FOR STEAM INJECTION AT ANY TIME DURING COOKING. Steam will inject into the cavity as long as the icon is touched.

When the operator-set internal temperature has been reached, an alarm will sound indicating the end of the operating mode.

- To stop the buzzer, press the red stop icon  or open the oven door.



TO STOP COOKING PROGRAM AT ANY TIME, PRESS RED STOP ICON.

### NOTE: CALIBRATE THE COMBITOUCH OVEN TO USE A SOUS-VIDE PROBE

With CombiTouch oven on, fill a pitcher of ice water and place inside the combi oven.

Remove the original hanging probe from inside the oven.

Snap sous-vide probe in place of the original probe at top of oven and insert probe into the pitcher of ice water.

Check the temperature by selecting the “probe” button on the cooking mode menu.

Once the temperature reading is 35 degrees, press the back arrow button in the lower left hand corner of the screen to return to the home screen.

Press the “Set-up Mode” button on the bottom left hand corner of the screen.

Adjust the temperature control back 3 degrees using the minus key, then press the back arrow to return to the home screen.

The control has now been calibrated to use the sous-vide probe.

# OPERATING INSTRUCTIONS



## DELTA-T CORE TEMPERATURE COOKING MODE

This special program function cooks by internal product temperature with the use of the probe. Unlike the standard core temperature mode however, the Delta-T oven temperature automatically increases in direct proportion to the internal temperature of the product. The Delta-T mode can be used with both convection and combination modes, providing a more gentle method of cooking. Browning occurs toward the end of the cooking cycle.



PRESS THE ON BUTTON TO POWER OVEN ON.

ATTACH REMOVABLE PROBE BEFORE ACTIVATING CORE TEMPERATURE FUNCTION, AND INSERT INTO PRODUCT.

The probe must be inserted so that the tip is positioned in the center of the food mass. For liquid or semi-liquid foods, suspend the probe in the center of the product and secure the probe wire to the edge of the container.

PRESS THE REQUIRED COOKING MODE ICON. The last set values or oven control default setting for temperature and time will appear in the display.

 TOUCH THE PROBE ICON.



The previously set core temperature or default setting will appear highlighted within the oven display. Touch the displayed core temperature. The internal product core temperature will appear at the top of the temperature selection window. Type in desired internal product core temperature or use up and down arrows to adjust temperature. When finished, touch the green check mark key  to confirm change.



PRESS THE DELTA-T ICON THAT APPEARS IN THE LOWER LEFT CORNER OF THE TOUCH SCREEN.



PRESS THE GREEN START ARROW ICON TO BEGIN COOKING.

- The actual internal product temperature will appear next to the  icon during operation. To change the set value for core temperature, press the temperature next to the  icon and make changes as required.



PRESS FOR STEAM INJECTION AT ANY TIME DURING COOKING. Each push of the icon will release one pulse of steam.

When the operator-set internal temperature has been reached, a buzzer will sound indicating the end of the operating mode.

- To stop the buzzer, press the red stop icon  or open the oven door.



TO STOP COOKING PROGRAM AT ANY TIME, PRESS RED STOP ICON.

# OPERATING INSTRUCTIONS

## AUXILIARY FUNCTIONS

All auxiliary functions can be engaged at any time during any cooking mode and can be programmed into cooking procedures. At the end of a cooking mode or program, the oven automatically disengages all auxiliary functions.

### PREHEATING FEATURE

SELECT DESIRED COOKING MODE.

 PRESS PREHEAT ICON.

The preheat temperature will appear at the top of the preheat temperature selection window. Type in desired temperature or use up and down arrows to adjust temperature. When finished, touch the green check mark key  to confirm change.

When the preheat temperature has been reached, a buzzer will sound indicating the end of the preheat function. To stop the buzzer, press the red stop icon . The preheat temperature will be maintained if the stop icon is not pressed.

### GOLD-N-BROWN FEATURE

The browning feature is an automatic function designed to regulate humidity to provide additional color to products as needed. This feature is particularly useful for adding color to high moisture products such as chicken and other poultry items, or for additional browning of full loads and other moist products. In addition, this feature may be used to add texture to fried items such as french fries or breaded chicken. Gold-n-Brown can be used in any cooking mode and can be programmed into a cooking procedure.

Browning can be used for any product. Depending on the type of product and product load, the browning feature may also slightly increase the set cooking time in order to fully complete the browning function. This is a standard operating condition of this feature.

SELECT DESIRED COOKING MODE.

ADJUST TEMPERATURE AND TIME SETTINGS.

 PRESS THE GOLD-N-BROWN ICON.

 Choose the desired Gold-n-Brown level. (Level 1 provides least amount of browning, level 6 the most.) After a level has been selected, the previous screen will be displayed and the Gold-n-Brown icon will be highlighted.

 PRESS THE GREEN START ARROW ICON TO BEGIN COOKING.

The oven will engage the browning feature in the cooking mode set by the operator. Gold-N-Brown can be used in steam mode to reduce moisture.

### OVEN COOL DOWN FEATURE

The cool-down feature provides the operator with the ability to lower the temperature of the oven compartment at an accelerated pace. This function is useful when it is necessary to immediately change from a high temperature cooking function to a lower temperature function or to the steam program. This function is also useful to help cool the oven compartment in preparation for cleaning.

#### CHEF OPERATING TIP

**When using the cool-down feature in preparation for cleaning, it is important to remember that the temperature in the display indicates the air temperature inside the oven compartment and not the interior walls of the oven. Always allow the oven walls to cool to a minimum of 140°F (60°C) before spraying the compartment with oven cleaner.**

 PRESS COOL DOWN ICON.

The cool down temperature will appear at the top of the cool down temperature selection window. Type in desired temperature between 50 and 200°F (10 and 93°C) or use up and down arrows to adjust temperature. When finished, touch the green check mark key  to confirm change.

OPEN OVEN DOOR.

A buzzer will sound indicating the end of the cool down function. Press the red stop icon  or open the oven door to stop the buzzer.

# OPERATING INSTRUCTIONS

## AUXILIARY FUNCTIONS

### REDUCED FAN SPEED

The reduced fan speed function is useful for flow-sensitive products such as soufflés and meringues, or any products affected by a high velocity of air movement.

SELECT DESIRED COOKING MODE AND SET MODE FUNCTIONS.



PRESS FAN SPEED ICON.

The FAN SPEED icon toggles between 100% and 50%.



PRESS THE GREEN START ARROW ICON TO BEGIN COOKING.

### REDUCED POWER

The reduced power function can be used to reduce kitchen power peaks and energy consumption.

SELECT DESIRED COOKING MODE AND SET MODE FUNCTIONS.



PRESS REDUCED POWER ICON.

The REDUCED POWER icon will be highlighted.



PRESS THE GREEN START ARROW ICON TO BEGIN COOKING.

The oven will operate with reduced power in whatever cooking mode is set by the operator.

**NOTE:** Reduced power will result in longer cooking times.

### MULTI-SHELF TIMER

The multi-shelf timer allows the operator to program alarm times for the oven shelves. This can be one common time for all shelves or individual times.

SET COOKING MODE, TEMPERATURE AND TIME. The time set by the user will be the default time for the shelf timers.



PRESS THE MULTI-SHELF TIMER ICON.

ADJUST TIME SETTINGS FOR EACH SHELF AND PRESS GREEN CHECK MARK KEY  TO CONFIRM CHANGE.



PRESS THE GREEN START ARROW ICON FOR EACH INDIVIDUAL SHELF. The unit will immediately start running in continuous operation mode.

When time expires for a shelf, the time background will turn red and an alarm will sound.

OPEN THE DOOR OR PRESS THE  RED STOP ICON TO SILENCE ALARM. Remove food as appropriate.

### STEAM INJECTION



Press to add moisture while in any cooking mode. Steam will inject into the cavity as long as the icon is touched.

### AUTOMATIC GREASE COLLECTION (OPTIONAL)



Press to activate while in any cooking mode. Separates grease from water, then pumps grease and by-products directly into a grease collection container.

# OPERATING INSTRUCTIONS

## COMBI-SMOKER® PROCEDURES

### LOAD WOOD CHIPS.

- Measure one container full of dry wood chips.
- Soak dry chips in water for 5 minutes.
- Shake excess water off wood chips.
- Place moistened chips back into the container and position the container securely on the two prongs located on the interior back panel of the oven.

A full container of wood chips will produce smoke for an approximate period of one to two hours depending on the cooking temperature being used for the selected product. The preprogrammed CombiTouch recipes have been tested to ensure complete product smoke penetration and full smoke flavor.

### CHEF OPERATING TIP

Products such as ribs that require heavier smoke penetration to reach full smoke flavor should remain in the oven after cooking has been completed. Do not open the oven door.

Set the oven in the Low Temperature Steam Mode at 140° to 160°F (60° to 71°C) and allow the product to remain in the oven for a period of one hour.

If you would like assistance, you are invited to contact an Alto-Shaam corporate chef for recommendations.

**NOTE:** Always keep the oven door closed whenever operating the smoking function.

The CombiTouch CombiSmoker can be operated without using the smoking function. After using the oven as a smoker, however, it is necessary to clean the oven in order to prevent a transfer of smoke flavor to non-smoked products. Cleaning instructions are provided in this manual.

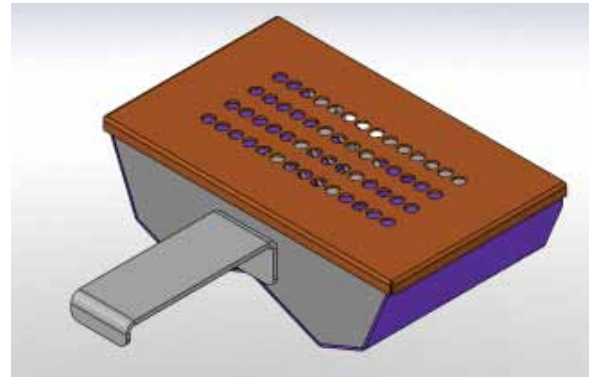

### AVAILABLE FROM ALTO-SHAAM

WOOD CHIPS	20 pound bulk packs
Apple	WC-22543
Hickory	WC-2829
Cherry	WC-22541
Sugar Maple	WC-22545

THE TOTAL WEIGHT OF WOOD CHIP BULK PACKS MAY VARY DUE TO HIGH MOISTURE CONTENT WHEN PACKAGED.



## CAUTION

**DO NOT OPEN THE OVEN DOOR DURING THE SMOKING FUNCTION.** The introduction of outside air in the oven compartment may cause the wood chips to flame.



## WARNING

**THE USE OF IMPROPER MATERIALS FOR THE SMOKING FUNCTION COULD RESULT IN DAMAGE, HAZARD, EQUIPMENT FAILURE, OR COULD REDUCE THE OVERALL LIFE OF THE OVEN.**

**DO NOT USE SAWDUST FOR SMOKING.  
DO NOT USE WOOD CHIPS SMALLER THAN THUMBNAIL SIZE.**

# OPERATING INSTRUCTIONS

## COMBISMOKER® PROCEDURES

The ability to smoke product, hot or cold, is offered on all boiler-free electric models and on all gas models. The smoking function can be engaged in either the Combination mode or the Convection mode of operation. The smoking function cannot be operated when the oven is operating in the steam mode or the retherm mode.



SELECT CONVECTION OR COMBINATION COOKING MODE.

### TO CHANGE THE TEMPERATURE:

TOUCH THE DISPLAYED TEMPERATURE.

Type desired temperature or use up and down arrows to adjust temperature then touch the green check mark key



to confirm.

### TO COOK BY TIME:

TOUCH THE DISPLAYED TIME.

The cooking time will appear at the top the time selection window. Type in desired time period or use up and down arrows to adjust time. When finished, touch the green check mark key  to confirm change.

Or, to set Continuous Operation mode, press the --:-- icon and touch the green check mark key to confirm.

### TO ACTIVATE COMBISMOKE:



Press the SMOKING icon. The icon will be highlighted on the screen.



PRESS THE GREEN START ARROW ICON TO BEGIN COOKING.

## CAUTION



**METAL PARTS OF THIS EQUIPMENT BECOME EXTREMELY HOT WHEN IN OPERATION. TO AVOID BURNS, ALWAYS USE HAND PROTECTION WHEN OPERATING THIS APPLIANCE.**



# OPERATING INSTRUCTIONS

## PREPROGRAMMED RECIPES

The CombiTouch Combitherm comes preprogrammed with more than 100 recipes and photo icons, covering most commonly prepared food items. CombiTouch also allows you to save up to 250 of your recipes and uploaded photos.

  Select RECIPE MODE from any screen.

Navigate to desired recipe icon using green NEXT and PREVIOUS SCREEN arrows. Press icon for desired recipe. Cooking steps will start immediately. (See 25-34 for a list of all preprogrammed recipes.)

MAIN MENU



RECIPE MODE

COOKING MODE MENU



RECIPE MODE

RECIPE MENU



STORED RECIPES

RECIPE RANGE DISPLAYED ON SCREEN

PREVIOUS SCREEN

EDIT RECIPES

PREVIOUS & NEXT SCREEN

PROGRAM/EDIT RECIPES



STORED RECIPES

MOVE SELECTED RECIPE

DELETE SELECTED RECIPE

EDIT SELECTED RECIPE

CONFIRM CHANGES

# OPERATING INSTRUCTIONS

## RECIPE PROGRAMMING VIA RECIPE MANAGEMENT SOFTWARE

The recipes can be edited, using the Touchscreen directly or with the Recipe Management Software. This Windows® based software and step-by-step instructions are available for download via the Alto-Shaam website.

<http://www.alto-shaam.com/combitouch.aspx>







DOWNLOAD  
LINK

## RECIPE PROGRAMMING VIA THE TOUCHSCREEN







### ADD A RECIPE

The recipe programming function allows the operator to program a cooking procedure using multiple cooking modes and any auxiliary functions desired. Recipes remain programmed until deleted by the operator.

1. Select any cooking mode.
2.  Click ADD RECIPE icon.
3. Select first desired cooking mode. Last input temperature, time and probe setting will be displayed.
4. Change temperature, time and/or cook by probe as desired.
5. Change auxiliary functions as desired (fan speed, Gold-N-Brown, Grease Collection, etc.)
6. When finished with cooking step, press  WRITE icon. Will display next cooking step programming screen.
7. Repeat steps 3 through 6 for each cooking step or proceed to step 8 if only one step in recipe.
8. When finished programming recipe, touch the  CONFIRM CHANGES icon.
9. A keypad will appear. Input name of recipe and assign a picture. Touch the picture icon to display the picture instead of text on recipe menu. Press  CONFIRM CHANGES icon.
10. The saved recipe will appear as the first recipe in the list.
11. Touch the newly saved recipe icon. Cooking steps in recipe will immediately start.



### EDIT A RECIPE

To edit an existing default or user-programmed recipe:

1.  Select RECIPE SETTINGS MODE from the Recipe Menu. The touch screen background will turn red to indicate that the user is in EDIT MODE.
2. Press the icon of the recipe to be edited. Selected recipe will be highlighted.
3. Press  EDIT RECIPE. The first cooking step in the recipe will be displayed.  
Or click  DELETE RECIPE to remove recipe.  
Click  CONFIRM CHANGES to confirm deletion.
4. Edit cooking mode, temperature, time, probe temperature and/or auxiliary functions.
5. Press  CONFIRM CHANGES. A keyboard will appear. Edit the title as appropriate. Select a picture if desired, by pushing the picture icon to view the picture library.  
Press  CONFIRM CHANGES at the bottom of the keyboard.
6. Press  CONFIRM CHANGES at the bottom of the touch screen to exit EDIT RECIPE mode.

# OPERATING INSTRUCTIONS

## PREPROGRAMMED BAKERY RECIPES

Icon	Recipe	Oven Mode	Temp	Time	Fan Speed	Smoker	Browning
	Bakery retherm	Retherm	275°F (135°C)	4 minutes	100%	--	--
	Brownies	Convection	325°F (163°C)	25 minutes	100%	--	--
	Cinnamon Rolls	Combination	350°F (177°C)	20 minutes	100%	--	--
	Cookies	Convection	325°F (163°C)	12 minutes	50%	--	--
	Croissants	Combination	325°F (163°C)	15 minutes	50%	--	--
	Danish Pastry	Combination	350°F (177°C)	15 minutes	100%	--	--
	Dinner Rolls	Combination	350°F (177°C)	10 minutes	100%	--	--
	French Bread	Combination	350°F (177°C)	20 minutes	100%	--	--
	Fruit Bread	Combination	300°F (149°C)	50 minutes	100%	--	--
	Fruit Pie	Combination	340°F (171°C)	30 minutes	100%	--	--
	Muffins	Convection	325°F (163°C)	15 minutes	50%	--	--
	Par-baked Bread (frozen)	Combination	340°F (171 °C)	15 minutes	100%	--	--
	Par-baked Rolls	Combination	350°F (177°C)	10 minutes	100%	--	--
	Proofing	Low Temp Steam	90°F (32°C)	30 minutes	50%	--	--
	Puff Pastry	Combination	350°F (177°C)	10 minutes	100%	--	--
	Sheet Cake	Convection	325°F (163°C)	20 minutes	50%	--	--

# OPERATING INSTRUCTIONS



## PREPROGRAMMED CONVENIENCE PRODUCT RECIPES

Icon	Recipe	Oven Mode	Temp	Time	Fan Speed	Smoker	Browning Level
	Chicken Wings	Combination	400°F (204°C)	10 minutes	100%	--	2
	Corn Dogs	Combination	350°F (177°C)	18 minutes	100%	--	1
	Egg Rolls	Combination	375°F (191°C)	15 minutes	100%	--	3
	Frozen Entrée: Cabbage Rolls	Combination	350°F (177°C)	160°F probe (71°C)	100%	--	--
	Frozen Entrée: Chicken Primavera	Combination	350°F (177°C)	160 minutes	100%	--	--
	Frozen Entrée: Macaroni & Beef	Combination	350°F (177°C)	145 minutes	100%	--	--
	Frozen Entrée: Macaroni & Cheese	Combination	350°F (177°C)	140 minutes	100%	--	--
	Frozen Entrée: Meat Lasagna	Combination	350°F (177°C)	150 minutes	100%	--	--
	Frozen Entrée: Ratatouille	Combination	350°F (177°C)	35 minutes	100%	--	--
	Frozen Entrée: Stuffed Peppers	Combination	350°F (177°C)	150 minutes	100%	--	--
	Hamburger Patties - Frozen	Combination	350°F (177°C)	12 minutes	100%	--	4
	Hamburger Patties - Thawed	Combination	350°F (177°C)	5 minutes	100%	--	--
	Hot Dogs - Low Temp Steam	Low Temp Steam	160°F (71°C)	13 minutes	50%	--	--
	Hot Dogs - Steamed	Steam	212°F (100°C)	10 minutes	100%	--	--
	Mini Pizza	Combination	350°F (177°C)	10 minutes	100%	--	--
	Precooked Chicken Pieces - Frozen (MRB)	Convection	365°F (185°C)	30 minutes	100%	--	3

(CONTINUED ON NEXT PAGE)









# OPERATING INSTRUCTIONS

## PREPROGRAMMED CONVENIENCE PRODUCT RECIPES (CONTINUED)

Icon	Recipe	Oven Mode	Temp	Time	Fan Speed	Smoker	Browning Level
	Precooked Chicken Pieces - Refrigerated	Convection	325°F (163°C)	20 minutes	100%	--	1
	Spring Rolls	Combination	375°F (191°C)	15 minutes	100%	--	--
	Tater Tots	Combination	375°F (191°C)	10 minutes	100%	--	3

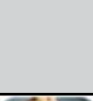











# OPERATING INSTRUCTIONS

## PREPROGRAMMED FISH & SEAFOOD RECIPES

Icon	Recipe	Oven Mode	Temp	Time	Fan Speed	Smoker	Browning Level
	Baked Fish - Fresh	Combination	400°F (204°C)	6 minutes	100%	--	2
	Grilled Fish Fillets	Combination	460°F (238°C)	4 minutes	100%	--	--
	Lobster - Whole	Steam	195°F (91°C)	13 minutes	50%	--	--
	Salmon - Cold Smoked	(1) Convection	34°F (1°C)	15 minutes	50%	On	--
		(2) Convection	34°F (1°C)	30 minutes	50%	Off	--
	Salmon - Filets	Low Steam	145°F (63°C)	7 minutes	50%	--	--
	Salmon - Steaks	Steam	145°F (63°C)	8 minutes	100%	--	--
	Shrimp - Smoked	Convection	34°F (1°C)	10 minutes	50%	On	--
	Shrimp - Steamed	Low Steam	160°F (71°C)	12 minutes	50%	--	--

# OPERATING INSTRUCTIONS



## PREPROGRAMMED MEAT RECIPES

Icon	Recipe	Oven Mode	Temp	Time	Fan Speed	Smoker	Browning Level
	Bacon	Combination	375°F (191°C)	10 minutes	100%	--	--
	Beef Brisket - Smoked	(1) Combination	225°F (107°C)	90 minutes	50%	On	--
		(2) Combination	225°F (107°C)	180 minutes	50%	--	--
	Beef Roast Cook & Hold	(1) Delta-T	125°F (52°C)	Probe 120°F (46°C)	50%	--	--
		(2) Steam	135°F (57°C)	Continuous	50%	--	2
	Beef Rounds - by Core Temp	Delta-T	130°F (54°C)	Probe 125°F (52°C)	100%	--	1
	Beef Rounds - by Time	Combination	250°F (121°C)	130 minutes	100%	--	--
	Beef Short Ribs	Combination	275°F (135°C)	90 minutes	100%	--	--
	Beef Short Ribs - Smoked	(1) Combination	275°F (135°C)	30 minutes	50%	On	--
		(2) Combination	275°F (135°C)	60 minutes	100%	--	--
	Beef Tenderloin	Combination	250°F (121°C)	Probe 125°F (52°C)	100%	--	2
	Beef Tri-tips	Combination	250°F (121°C)	Probe 125°F (52°C)	100%	--	3
	Breakfast Sausage Links	Combination	350°F (177°C)	8 minutes	100%	--	--
	Grilled Pork Chops	Combination	460°F (238°C)	6 minutes	100%	--	1
	Grilled Steaks	Combination	460°F (238°C)	Probe 130°F (54°C)	100%	--	--

(CONTINUED ON NEXT PAGE)

# OPERATING INSTRUCTIONS

## PREPROGRAMMED MEAT RECIPES (CONTINUED)

Icon	Recipe	Oven Mode	Temp	Time	Fan Speed	Smoker	Browning Level
	Ham - by Core Temp	Delta-T	125°F (52°C)	Probe 150°F (66°C)	50%	--	--
	Leg of Lamb - by Core Temp	Delta-T	125°F (52°C)	Probe 130°F (54°C)	100%	--	2
	Meat Loaf - by Core Temp	Combination	275°F (135°C)	Probe 155°F (68°C)	100%	--	3
	Pork - Back Ribs - Raw	Combination	250°F (121°C)	45 minutes	100%	--	--
	Pork - Back Ribs - Smoked	(1) Combination	250°F (121°C)	60 minutes	100%	On	--
		(2) Steam	160°F (71°C)	Continuous	50%	--	--
	Pork - Loin Roast - by Core Temp	Combination	300°F (149°C)	Probe 150°F (66°C)	100%	--	2
	Pork Ribs Reheat	Combination	400°F (204°C)	7 minutes	100%	--	--
	Pork Shoulder - Smoked	(1) Combination	225°F (107°C)	90 minutes	100%	On	--
		(2) Combination	225°F (107°C)	Probe 185°F (85°C)	--	--	--
	Rack of Lamb - by Core Temp	Delta-T	130°F (54°C)	130 minutes	100%	--	2
	Sausage - Fresh - by Low Temp Steam	Low Temp Steam	160°F (71°C)	15 minutes	50%	--	--















# OPERATING INSTRUCTIONS

## PREPROGRAMMED MISCELLANEOUS RECIPES

Icon	Recipe	Oven Mode	Temp	Time	Fan Speed	Smoker	Browning Level
	Casseroles - by Core Temp	Combination	350°F (177°C)	Probe 150°F (66°C)	100%	--	--
	Casseroles - Time	Combination	350°F (177°C)	30 minutes	100%	--	--
	Custard/Crème Brulee	Low Temp Steam	190°F (88°C)	45 minutes	50%	--	1
	Eggs - Hardboiled	Steam	212°F (100°C)	12 minutes	100%	--	--
	Eggs - Poached - Low Temp Steam	Low Temp Steam	170°F (77°C)	5 minutes	50%	--	--
	Eggs - Poached - Steamed	Steam	212°F (100°C)	3 minutes	100%	--	--
	Eggs - Scrambled in bag; shake at 18 minutes	Steam	212°F (100°C)	25 minutes	100%	--	--
	Eggs - Scrambled in pan	Steam	212°F (100°C)	15 minutes	100%	--	--
	Eggs - Sous Vide	Steam	148°F (64°C)	45 minutes	50%	--	--
	French Fries - Full Load	(1) Convection	400°F (204°C)	1 minute	100%	--	4
		(2) Combination	400°F (204°C)	9 minutes	100%	--	2
	Pasta	Steam	212°F (100°C)	20 minutes	100%	--	--
	Pate en Croute - by Core Temp	(1) Convection	350°F (177°C)	10 minutes	100%	--	--
		(2) Combination	350°F (177°C)	Probe 135°F (57°C)	100%	--	--
	Pizza - Fresh	Combination	400°F (204°C)	10 minutes	50%	--	1
	Rice	Steam	212°F (100°C)	20 minutes	100%	--	--
	Soup in Bag	Steam	230°F (110°C)	50 minutes	100%	--	--
	Tamales	Steam	212°F (100°C)	30 minutes	100%	--	--

# OPERATING INSTRUCTIONS

## PREPROGRAMMED POULTRY RECIPES

Icon	Recipe	Oven Mode	Temp	Time	Fan Speed	Smoker	Browning Level
	Chicken - Frozen Pieces	Combination	350°F (177°C)	30 minutes	100%	--	3
	Chicken - Oven Fried Pieces	Combination	450°F (232°C)	18 minutes	100%	--	--
	Chicken - Thawed Whole	Combination	350°F (177°C)	35 minutes	100%	--	1
	Chicken - Thawed Whole - by Core Temp	Combination	350°F (177°C)	Probe 175°F (79°C)	100%	--	1
	Chicken - Whole Smoked	(1) Convection	34°F (1°C)	15 minutes	50%	On	--
		(2) Combination	350°F (177°C)	Probe 175°F (79°C)	50%	--	--
	Chicken baked - Thawed Pieces	Combination	375°F (191°C)	Probe 170°F (77°C)	100%	--	2
	Duck Pieces - Raw	Combination	375°F (191°C)	25 minutes	100%	--	4
	Duck Whole - by Core Temp	(1) Combination	250°F (121°C)	15 minutes	100%	--	--
		(2) Combination	300°F (149°C)	10 minutes	100%	--	--
		(3) Combination	400°F (204°C)	Probe 175°F (79°C)	100%	--	3
	Galantine - by Core Temp	Low Temp Steam	160°F (71°C)	Probe 135°F (79°C)	50%	--	--
	Grilled Chicken Breasts	Combination	460°F (238°C)	6 minutes	100%	--	--
	Turkey Breast - Precooked - by Time	Combination	275°F (135°C)	Probe 155°F (68°C)	50%	--	--
	Turkey Breast - Raw - by Core Temp	Combination	275°F (135°C)	Probe 155°F (68°C)	50%	--	1
	Turkey Breast - Smoked	(1) Combination	275°F (135°C)	60 minutes	50%	On	--
		(2) Combination	275°F (135°C)	Probe 155°F (68°C)	100%	--	--

# OPERATING INSTRUCTIONS









## PREPROGRAMMED VEGETABLE RECIPES

Icon	Recipe	Oven Mode	Temp	Time	Fan Speed	Smoker	Browning Level
	Asparagus - Fresh	Steam	190°F (88°C)	3 minutes	50%	--	--
	Asparagus - Frozen	Steam	212°F (100°C)	5 minutes	100%	--	--
	Baked Potatoes	Combination	350°F (177°C)	40 minutes	100%	--	1
	Beets - Fresh	Steam	230°F (110°C)	20 minutes	100%	--	--
	Broccoli - Fresh	Steam	212°F (100°C)	6 minutes	100%	--	--
	Broccoli - Frozen	Steam	212°F (100°C)	3 minutes	100%	--	--
	Brussel Sprouts - Frozen	Steam	212°F (100°C)	6 minutes	100%	--	--
	Cabbage - Fresh	Steam	212°F (100°C)	10 minutes	100%	--	--
	Carrots - Fresh	Steam	225°F (107°C)	10 minutes	100%	--	--
	Carrots - Frozen	Steam	212°F (100°C)	6 minutes	100%	--	--
	Cauliflower - Fresh	Steam	212°F (100°C)	5 minutes	100%	--	--
	Cauliflower - Frozen	Steam	212°F (100°C)	4 minutes	100%	--	--
	Corn (Kernels) - Frozen	Steam	212°F (100°C)	4 minutes	100%	--	--
	Corn-on-the-Cob - Fresh	Steam	212°F (100°C)	14 minutes	100%	--	--
	Corn-on-the-Cob - Frozen	Steam	212°F (100°C)	10 minutes	100%	--	--

(CONTINUED ON NEXT PAGE)

# OPERATING INSTRUCTIONS

## PREPROGRAMMED VEGETABLE RECIPES (CONTINUED)

Icon	Recipe	Oven Mode	Temp	Time	Fan Speed	Smoker	Browning Level
	Green Beans - Fresh	Steam	212°F (100°C)	8 minutes	100%	--	--
	Green Beans - Frozen	Steam	212°F (100°C)	5 minutes	100%	--	--
	Parsnips - Fresh	Steam	230°F (110°C)	10 minutes	100%	--	--
	Peas - Frozen	Steam	212°F (100°C)	4 minutes	100%	--	--
	Potatoes, Red or Salad	Steam	212°F (100°C)	30 minutes	100%	--	--
	Squash - Fresh	Steam	212°F (100°C)	3 minutes	100%	--	--
	Turnips - Fresh	Steam	230°F (110°C)	10 minutes	100%	--	--
	Zucchini - Fresh	Steam	212°F (100°C)	3 minutes	100%	--	--

# OPERATING INSTRUCTIONS

## HACCP ACCESS

The CombiTouch Combitherm meets the requirements of established HACCP criteria by providing automated sampling, record keeping, set-point validation, recipe used, dates and time. Data is captured when Core Temperature Probe cooking method is chosen. This data is retained for the last 30 days. This information can be viewed on screen or downloaded to a USB drive and then copied to your computer. The file format is text (.txt).

**NOTE:** You access this information from the Settings Screen. See illustrations on page 3 and 4 for navigation.

**CAUTION:** The CombiOven USB port is not recommended for use with personal hand held devices.

1. To download the data collected, remove the cap of a USB port located on the left side of the oven and insert the USB flash drive. If the flash drive is not recognized by the Combitherm, a question mark will appear on screen. Try again with another flash drive device or call Alto-Shaam Service.



2. PRESS TO DOWNLOAD INFORMATION.



3. WAIT FOR THE ICON TO CHANGE FROM LOADING TO COMPLETE.



4. PRESS TO CONFIRM TRANSFER.

5. Remove the USB flash drive and replace the cap on the USB port located on the left side of the oven.

The download process will automatically create a folder on the USB flash drive titled "haccp". Each text file contains cooking program specifics. See illustration below.



```
HACCP
Unit:                00:30:06:FF:28:63
Date:                2011-01-09
Program:             Steam
Start time:          22:10:31
Stop time:           22:14:37
Elapsed cook time:   00:04
Multi shelf timer:   no
Reduced energy:      no
Recipe active:       no
Temperature unit:    °F
Cavity start temperature: 191
Cavity stop temperature: 217
Cavity temperature reached: 00:02
Core start temperature: 176
Core stop temperature: 215
Core temperature reached: 00:00
Door open count:     0
```

# CLEANING & MAINTENANCE

The CombiTouch Combitherm offers four (4) cleaning levels: rinse, light, normal, and heavy-duty cleaning. CombiClean® tablets or Combitherm liquid spray cleaner may be used. Side racks, shelves and trolleys may remain inside oven during cleaning.

**Note:** *If a power outage were to occur during any of the cleaning cycles, the oven will begin a six (6) minute forced-rinse cycle.*



**SELECT CLEANING MODE FROM ANY SCREEN.**

**NOTE:** If oven is too hot to safely clean, an oven with red interior will appear on the screen and the cool down function is automatically activated. Allow oven to cool to 200°F (93°C) before cleaning.



PRESS GREEN WATER ON ICON TO CONFIRM THAT WATER SUPPLY IS TURNED ON.



SELECT RINSE, LIGHT, NORMAL, OR HEAVY-DUTY CLEANING.

INSERT APPROPRIATE NUMBER OF COMBICLEAN TABLETS as directed by touchscreen or spray interior of oven with combitherm liquid spray cleaner. User may add one additional tablet in either normal or heavy duty modes for particularly dirty ovens.



PRESS THE GREEN START ARROW ICON TO BEGIN CLEANING.

Leave door slightly ajar when cleaning is finished.

## CLEANING MODE MENU

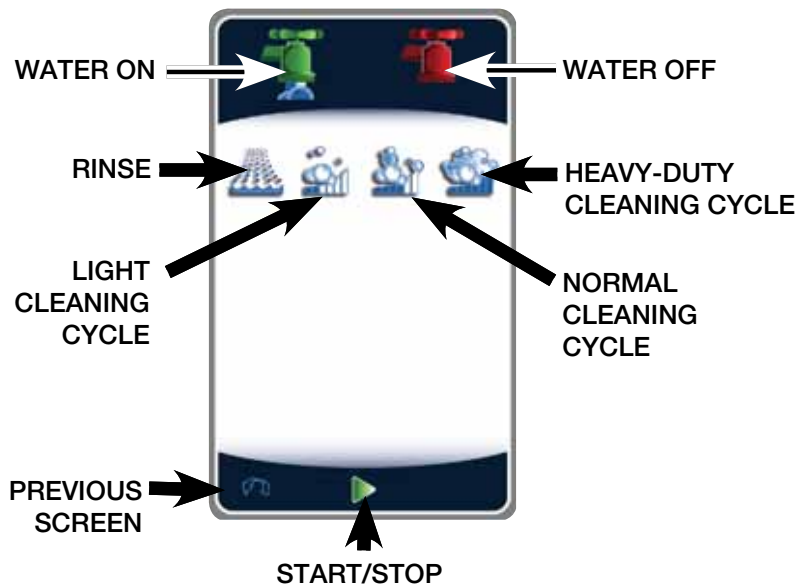

## COMBI CLEANER REQUIREMENT

The number of required CombiClean tabs is shown via an animation



## CLEANING IN PROCESS



## OVEN TOO HOT WARNING

Must allow oven to cool down before inserting CombiClean tabs or spraying with cleaner



# CLEANING & MAINTENANCE

## GREASE COLLECTION HOOK-UP (IF EQUIPPED WITH THIS FEATURE)

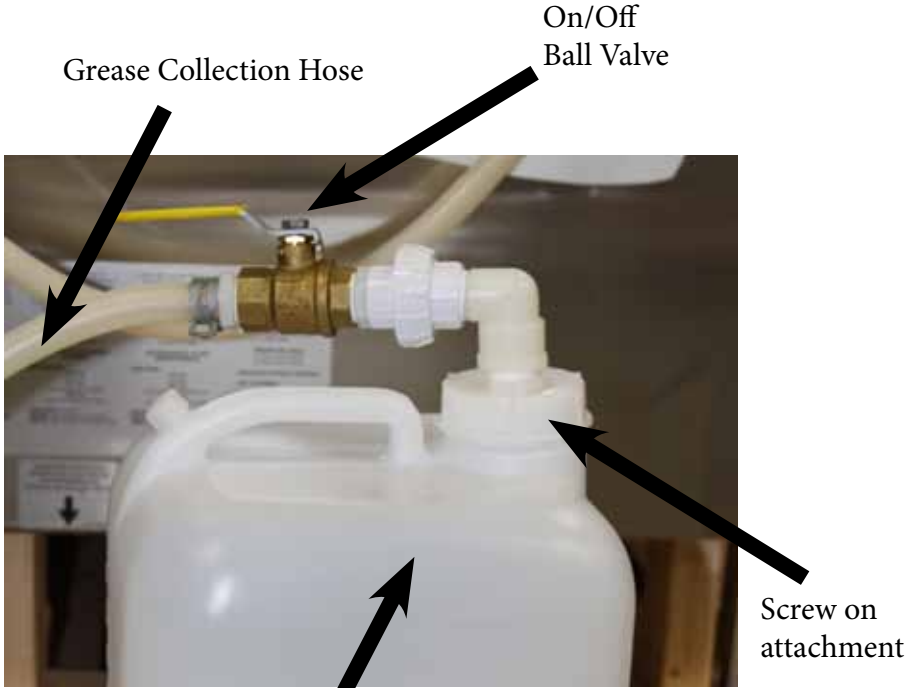

- Grease Collection Hose Assembly is attached to the oven in the back.
- Place Grease Collection Containers inside the tray of the Mobile Grease Collection Cart. Roll into place next to the oven.
- Remove cap from container. Pull out the Grease Collection Hose Assembly from the back of the unit.
- Screw on to collection container until snug.
- Turn ball valve handle to the **ON** position.
- Automatic Grease Collection System is electronically activated during the chicken cooking process [PATENT PENDING]. It is designed to save labor and provide greater employee safety by eliminating the need to handle hot grease in shallow pans.

Optional  
Mobile  
Grease  
Collection  
Cart

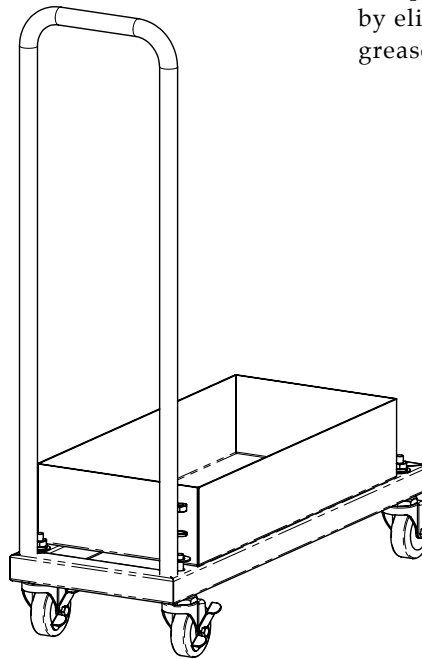

# CLEANING & MAINTENANCE

## PREVENTATIVE MAINTENANCE

In addition to the routine cleaning and maintenance procedures, there are several additional steps to be taken for both sanitation and to keep the oven running efficiently. These additional safeguards will help prevent down time and costly repairs.

### **DO NOT DISPOSE OF GREASE, FAT, OR SOLID WASTE DOWN THE OVEN DRAIN.**

Fats and solids will eventually coagulate in the drain system, causing blockage. Consequently, water will back-up into the condenser and interior oven compartment, resulting in an oven that is inoperable.

### **MAKE CERTAIN THE DRAIN SCREEN IS ALWAYS IN PLACE. REMOVE ANY SOLID WASTE MATERIAL FROM THE DRAIN SCREEN BEFORE IT ENTERS THE DRAIN SYSTEM.**

The routine removal of solids from the drain screen will help prevent blockage.

### **USE THE AUTHORIZED COMBITHERM OVEN CLEANER ONLY.**

The use of unauthorized cleaning agents may discolor or harm the interior surfaces of the oven.

### **TO PROLONG THE LIFE OF THE DOOR GASKET, CLEAN THIS ITEM DAILY.**

The acids and related compounds found in fat, particularly chicken fat, will weaken the composition of the gasket unless cleaned on a daily basis. Wipe with a hot, soapy cloth.

### **TO ADDITIONALLY PROTECT GASKET LIFE, ALLOW OVEN DOOR TO REMAIN SLIGHTLY OPEN AT THE END OF THE PRODUCTION DAY.**

An open door will relieve the pressure on the door gasket.

### **ROUTINELY CLEAN DOOR HINGES.**

Open oven door to relieve tension. Clean all parts of the hinge.

### **CLEAN PRONGS OF REMOVABLE PROBE DAILY.**

To ensure accurate internal product temperature readings, the prongs on the removable probe must be cleaned daily.



## ROLL-IN CART/FOOD TROLLEY CLEANING (ON EQUIPPED MODELS)

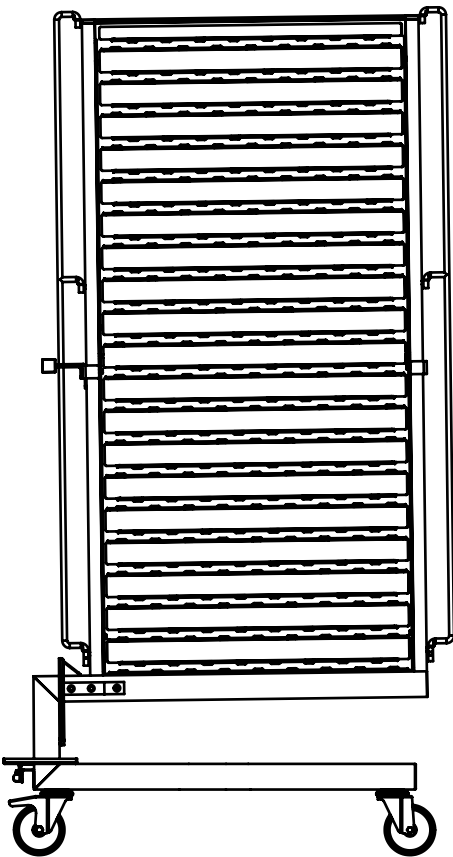

1. Remove food trolley to a cart wash area. Trolleys may be cleaned using any mild cleaning detergent and warm water.
2. Hand wipe all framing, slides, drip pan, and base. Thoroughly clean debris from the casters. A spray hose can be used for easier cart cleaning.
3. Remove detergent solution with warm water.
4. Wipe or spray with a sanitizing solution designed for use on metal and vinyl food contact surfaces.
5. Allow trolley to air dry.

As an alternative, trolleys can be cleaned while inside the oven. Allow the trolley to remain in the oven through the normal cleaning cycle, followed by steps 2 through 5 above.



# CLEANING & MAINTENANCE

## CLEANING AND PREVENTATIVE MAINTENANCE

### PROTECTING STAINLESS STEEL SURFACES



It is important to guard against corrosion in the care of stainless steel surfaces. Harsh, corrosive, or inappropriate chemicals can completely destroy the protective surface layer of stainless steel. Abrasive pads, steel wool, or metal implements will abrade surfaces causing damage to this protective coating and will eventually result in areas of corrosion. Even water, particularly hard water that contains high to moderate concentrations of chloride, will cause oxidation and pitting that result in rust and corrosion. In addition, many acidic foods spilled and left to remain on metal surfaces are contributing factors that will corrode surfaces.





Proper cleaning agents, materials, and methods are vital to maintaining the appearance and life of this appliance. Spilled foods should be removed and the area wiped as soon as possible but at the very least, a minimum of once a day. Always thoroughly rinse surfaces after using a cleaning agent and wipe standing water as quickly

### CLEANING AGENTS

Use non-abrasive cleaning products designed for use on stainless steel surfaces. Cleaning agents must be chloride-free compounds and must not contain quaternary salts. Never use hydrochloric acid (muriatic acid) on stainless steel surfaces. Always use the proper cleaning agent at the manufacturer's recommended strength. Contact your local cleaning supplier for product recommendations.

### CLEANING MATERIALS

The cleaning function can usually be accomplished with the proper cleaning agent and a soft, clean cloth. When more aggressive methods must be employed, use a non-abrasive scouring pad on difficult areas and make certain to scrub with the visible grain of surface metal to avoid surface scratches. Never use wire brushes, metal scouring pads, or scrapers to remove food residue.

 <b>CAUTION</b>	
 NO SCRAPERS	<b>TO PROTECT STAINLESS STEEL SURFACES, COMPLETELY AVOID THE USE OF ABRASIVE CLEANING COMPOUNDS, CHLORIDE BASED CLEANERS, OR CLEANERS CONTAINING QUATERNARY SALTS. NEVER USE HYDROCHLORIC ACID (MURIATIC ACID) ON STAINLESS STEEL. NEVER USE WIRE BRUSHES, METAL SCOURING PADS OR SCRAPERS.</b>
 NO WIRE BRUSHES	
 NO STEEL PADS	

# CLEANING & MAINTENANCE

## CLEANING SCHEDULE

### DAILY GASKET CLEANING

It is important to prolong the life of the oven gasket by cleaning on a daily basis. Routine cleaning will help protect the gasket from deterioration caused by acidic foods.

1. Allow the oven to cool, then wipe the gasket and crevices with clean cloth soaked in warm detergent solution.
2. Wipe the gasket and crevices with a cloth and clean rinse water.

Do not attempt to remove gasket or place in the dishwasher.

### PROBE USAGE AND CLEANING

After each use of the **CORE TEMP** mode, wipe the probe tip with a clean paper towel to remove food debris. Follow by wiping the probe with a disposable alcohol pad. Return the probe to the proper door bracket position.

#### Probe Cleaning Procedures

1. Remove all food debris from probe between loads and at the end of each production shift. Wipe the entire probe, probe cable assembly, and probe holding bracket with a clean cloth and warm detergent solution.
2. Remove detergent by wiping the probe, cable, and bracket with a cloth and clean rinse water.
3. Wipe probe and probe bracket with disposable alcohol pad or sanitizing solution recommended for food contact surfaces.
4. Allow probe and cable to air dry in the probe holding bracket.
5. Wipe the probe with a disposable alcohol pad prior to inserting into a new food product.

### DAILY OVEN CLEANING

To be performed at the end of the production day or between production shifts.

### DAILY STEAM GENERATOR FLUSH

(Electric boiler equipped models only)

See next page for instructions

The steam generator must be flushed once a day when operating the oven on a regular basis. This procedure will prevent lime deposits and scale build-up from forming in the steam generator. A steam generator flush is automatically initiated during the cleaning function.

### DAILY PRONG CLEANING

To ensure accurate internal product temperature readings, the prongs on the removable probe must be cleaned daily.



1. Remove all food debris from prongs at the end of each production shift. Wipe the entire prong casing, and between each prong with a clean cloth and warm detergent solution.
2. Remove detergent by wiping with a cloth and clean rinse water.
3. Allow to air dry before replacing detachable probe.

### DAILY GREASE COLLECTION EQUIPMENT CLEANING

To be performed at the end of the production day or between production shifts.

1. Wipe the grease collection cart, tray, handle, containers, and caps with clean cloth soaked in warm detergent solution.
2. Wipe the grease collection cart, tray, handle, containers, and caps with a cloth and clean rinse water.

Do not attempt to place container caps in the dishwasher.

### MONTHLY CLEANING

1. Spray Head
2. Water Intake Filters
3. Drain Pipe

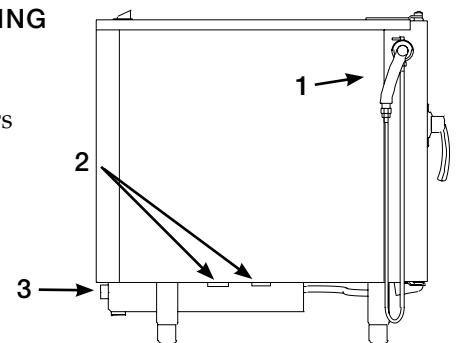

# CLEANING & MAINTENANCE

## COMBICLEAN CLEANING AGENTS



### DANGER

**RUBBER GLOVES MUST BE WORN WHEN USING COMBICLEAN TABLETS OR SPRAY OVEN CLEANER.**



### DANGER

**PROTECTIVE EYE WEAR MUST BE WORN WHEN USING SPRAY OVEN CLEANER.**

**NOTE:** Use authorized Combitherm cleaner only.

Unauthorized cleaning agents may discolor or harm interior surfaces of the oven. Read and understand label and material safety data sheet before using the oven cleaner.

**CAUTION:** Causes eye, skin, and respiratory tract irritation. keep out of reach of children.

#### PRECAUTIONS:

- Do not take internally.
- Avoid contact with eyes and skin.
- Use rubber gloves when using this product.
- Wash hands thoroughly after handling.
- Avoid mixing with strong, concentrated acids.

#### FIRST AID:

**Skin:** Flush with water. Remove contaminated clothing and do not re-wear until washed. If irritation persists see a physician.

**Eyes:** Flush with water for 15 minutes. See a physician immediately.

**Inhalation:** If difficulty in breathing occurs, leave area immediately and do not return until dust is settled. If irritation persists, see a physician.

**Ingestion:** Drink large quantities of milk or water. DO NOT INDUCE VOMITING. See a physician immediately.

**PROTECTIVE PACKAGING OF TABLETS WILL BEGIN TO DISSOLVE ONTO SKIN IF HANDLED WITH DAMP OR WET HANDS.**

## AUTOMATIC STEAM GENERATOR FLUSH

Flushing the electric Combitherm steam generator on a daily basis helps prolong the life of the steam generator heating elements and reduces the need for service. The CombiTouch provides this feature as an automatic function once every 24 hours.

The steam generator flush is automatically activated when the oven is powered on if no cleaning program has run during the last 24 hours. An indicator icon will notify the

user that flushing is in process. This function cannot be manually turned on or off and users cannot start a cooking sequence during the generator flush. Wait until the flush cycle is finished, then begin to use the oven as normal.

If the operator cleans the oven daily, it will not automatically flush as this is one of the functions of the cleaning cycles.

#### REGULAR DECALCIFICATION

It is important to decalcify the steam generator, and other plumbing components, particularly in areas with extremely hard water. In addition to the daily steam generator flush, this procedure should be performed once a month by a qualified service technician or more frequently depending on usage and water conditions.

# CLEANING & MAINTENANCE

## DECALCIFICATION - USING SCALEFREE™

ScaleFree™ Descaling Compound is an acid-based descaler combined with a proprietary chelating agent that is effective in dissolving and removing carbonate, lime-scale and iron-scale build-up caused by hard water. ScaleFree efficiently and effectively removes lime-scale build-up from combi ovens.

ScaleFree™ is a non-hazardous, Biodegradable Citrus Based Powder that when mixed with water becomes a powerful lime-scale remover.

**DO NOT COOK IN ANY PROGRAM MODE WITH SCALEFREE™ IN THE SYSTEM.**

Decalcification should be performed once a month in addition to the daily steam generator flush.

**Note:** *If a power outage were to occur during any of the cleaning cycles, the oven will begin a six (6) minute forced-rinse cycle.*



### ON COUNTER TOP BOILER EQUIPPED MODELS:

Mix up 1 gallon of ScaleFree solution using 1 cup [8 scoops] of ScaleFree granules with 1 gallon of water *or* 1 gallon of distilled white vinegar.

### ON FLOOR STANDING BOILER EQUIPPED MODELS:

Mix up 3 gallons of ScaleFree solution using 3 cups [21 scoops] of ScaleFree granules with 3 gallons of water *or* 3 gallons of distilled white vinegar.

**TURN OFF THE OVEN.** Place a catch basin underneath the back of the oven, toward the left side. Using *hand protection for hot surfaces*, remove the NPT cap with a 1-3/16" hex head socket wrench and allow *all* the water to drain from the boiler. Replace the NPT cap and tighten (see illustration below).

Open oven door. Using *hand protection for hot surfaces*, loosen the screw(s) with a flat head screwdriver and swing Fan Guard Cover Plate toward the back of the oven to gain access to the Steam Exit Port.

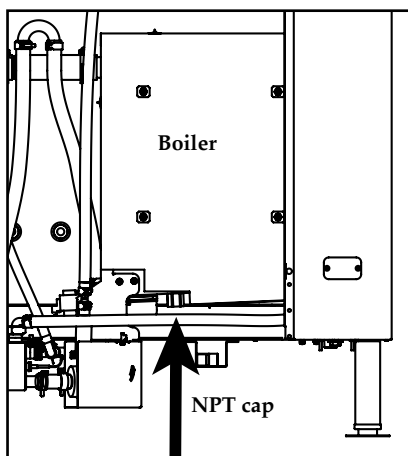

Using a funnel with a flexible hose inserted into the Steam Exit Port, slowly pour solution in to the Steam Generator until full. Continue with the next steps that are used for all models.

### ON ALL MODELS:

Press the ON/OFF power key to the ON position.

 SELECT CLEANING MODE FROM ANY SCREEN.

**NOTE:** If oven is too hot, an oven with red interior will appear on the screen and the cool down function is automatically activated. Allow oven to cool to 200°F (93°C) before cleaning.



PRESS GREEN WATER ON ICON TO CONFIRM THAT WATER SUPPLY IS TURNED ON.



SELECT HEAVY-DUTY CLEANING. Program will take 2 hours and 5 minutes to run.

Lift the oven drain screen. Pour 1 cup [8 scoops] of ScaleFree granules down the oven drain. Do *NOT* put CombiClean Tablets in oven drain during the decalcification procedure. On floor standing models, roll trolley into oven. Close oven door.



PRESS THE GREEN START ARROW ICON TO BEGIN CLEANING.

Open the oven door when cleaning cycle has finished.

Using *hand protection for hot surfaces*, loosen the Fan Guard Cover Plate screw(s) and swing Fan Guard Cover toward the back of the oven. Using the hand-held hose, rinse the area behind the Fan Guard Cover. Close the swing-out cover. Lock the cover into place and tighten screw(s) with a flat head screwdriver.

Using the hand-held hose, direct a stream of water directly into the oven drain for a minute or more.

Press the ON/OFF power key to the OFF position.

When the oven has completely powered down, press the ON/OFF power key to the ON position. A new supply of fresh water will begin to flush through the system.

The unit is now ready to use. Leave door slightly ajar when decalcification / cleaning is finished.

## EMERGENCY OPERATION MODE

If the oven malfunctions, an error code will appear in the display. In the event of an error, the Combitherm may be operated on a limited basis. Error conditions under which continued operation is possible are indicated by "Yes" in the chart on the next page. To operate the oven in the event of an error code:



**PRESS THE START ICON TO ACKNOWLEDGE THE ERROR.**

The icons that begin to flash represent operational modes that are still usable.

SELECT ONE OF THE AVAILABLE COOKING MODES.

SET THE OVEN CONTROLS AS IF OPERATING UNDER NORMAL CIRCUMSTANCES.

Depending on the error code involved, oven function, such as temperature range, may be limited.



**PRESS THE START ICON TO BEGIN COOKING.**



**PRESS THE STOP ICON WHEN TIMER EXPIRES.**

The Combitherm will return to normal operation when the oven fault is corrected.

# TROUBLESHOOTING

## EMERGENCY OPERATION MODE (CONTINUED)

### ERROR CODES

When the oven malfunctions, an error code will appear in the display.



**PRESS THE START ICON TO ACKNOWLEDGE THE ERROR.**

The icons that begin to flash represent operational modes that are still usable.

When the oven fault is corrected, the Combitherm will return to normal operation.

Error Code	Display Shows	Model		Mode			
		ES	ESG ESI	Steam	Combination	Convection	Retherm
<b>E01</b>	Low Water Boiler	Yes	No	No	No	To 365°F/185°C	No
<b>E02</b>	Control Temp High	Yes	Yes	No	No	No	No
<b>E03</b>	Fan Motor Error	Yes	Yes	No	No	No	No
<b>E04</b>	Fan Motor 2 Error	Yes	Yes	No	No	No	No
<b>E11</b>	Convection Temperature High	Yes	Yes	BOILER UNITS ONLY	No	No	No
<b>E13</b>	Boiler Temperature High	Yes	No	No	No	Yes	No
<b>E15</b>	Condenser Temperature High	Yes	Yes	No	No	To 356°F/180°C	No
<b>E20</b>	B11 Core Temperature Probe Single Point Fault - HACCP only	Yes	Yes	No	No	No	No
<b>E21</b>	N6 Cavity Probe Fault	Yes	Yes	BOILER UNITS ONLY	No	No	No
<b>E22</b>	B10 Core Temp Probe Fault	Yes	Yes	BY TIME ONLY	BY TIME ONLY	BY TIME ONLY	BY TIME ONLY
<b>E23</b>	B4 Boiler Probe Fault	Yes	No	No	No	No	No
<b>E24</b>	B5 Bypass Probe Fault	Yes	Yes	No	No	Yes	No
<b>E25</b>	B3 Condenser Probe Fault	Yes	Yes	Yes	No	To 356°F/180°C	No
<b>E26</b>	N8 Boiler Safety Temperature Probe Fault	Yes	No	No	No	No	No
<b>E27</b>	Boiler Element Temperature High	Yes	No	No	No	Yes	No
<b>E34</b>	Steam Generator Drain Pump Fault	Yes	No	No	No	No	No
<b>E36</b>	Steam Temperature High	Yes	No	No	No	Yes	No
<b>E51</b>	No Water in Boiler	Yes	No	No	No	Yes	No
<b>E53</b>	Fan Motor High Temperature	Yes	Yes	No	No	No	No
<b>E54</b>	Fan Motor 2 High Temperature	Yes	Yes	No	No	No	No
<b>E55</b>	Vent Not Open	Yes	Yes	Yes (NO BROWNING)	Yes (NO BROWNING)	Yes (NO BROWNING)	Yes (NO BROWNING)
<b>E57</b>	No Rinse Water	Yes	Yes	Yes	Yes	Yes	Yes
<b>E93</b>	Communication Error FROM Display Board	Yes	Yes	No	No	No	No
<b>E94</b>	Communication Error TO Display Board	Yes	Yes	No	No	No	No

## CombiTouch ERROR CODES

*This section is provided for the assistance of qualified technicians only and is not intended for use by untrained or unauthorized service personnel. If your Alto-Shaam® unit is not operating properly, check the following before calling your Authorized Alto-Shaam Service Agent:*

- Check that unit is receiving power. Plug in outlet? Circuit breaker turned on?  
*Do not attempt to repair or service the oven beyond this point. Contact Alto-Shaam for the nearest authorized service agent. Repairs made by any other service agents without prior authorization by Alto-Shaam will void the warranty on the unit.*

When the oven malfunctions, an error code will appear in the display.

 **PRESS THE START ICON TO ACKNOWLEDGE THE ERROR.**

The icons that begin to flash represent operational modes that are still usable.

When the oven fault is corrected, the Combitherm will return to normal operation.

<b>Error Code</b>	<b>Error Call Out in Display</b>	<b>Description of Error</b>	<b>Possible Cause</b>
<b>E01</b>	Low Water Boiler	Low water level in boiler	<ul style="list-style-type: none"> <li>— Water supply is shut off.</li> <li>— Low water pressure.</li> <li>— Generator drain cap missing or loose.</li> <li>— Generator drain pump is not sealing.</li> <li>— Generator drain pump elbow leaking.</li> <li>— Faulty or scaled water level probe.</li> <li>— Faulty or plugged dual solenoid valve assembly.</li> <li>— Wiring or connection issue.</li> <li>— No output to dual solenoid from relay board.</li> <li>— Relay board, high voltage is not operating.</li> </ul>
<b>E02</b>	Control Temperature High	Relay board surface temperature too high	<ul style="list-style-type: none"> <li>— Wiring or connection issue.</li> <li>— Cooling fan on Relay board assembly is not operating.</li> <li>— Cooling Fan on display board is not operating.</li> <li>— Main Cooling fan is not operating.</li> <li>— Cooling Fan on motor drive is not operating.</li> <li>— Unit is less than 20" from a heat producing source on its left hand side.</li> </ul>
<b>E03</b>	Fan Motor Error	Fan motor does not work	<ul style="list-style-type: none"> <li>— Exhaust hood is not operating properly.</li> <li>— Check LED flashes on the Motor Control.</li> <li>— <b>See Motor Control Error Code list.</b></li> <li>— Connection Issue on Hall Effect sensor.</li> <li>— Fan wheel is not operating.</li> <li>— Hall sensor does not detect motor rotation.</li> </ul>
<b>E04</b>	Fan Motor 2 Error	Lower fan motor on 20•20 does not work	<ul style="list-style-type: none"> <li>— Exhaust hood is not operating properly.</li> <li>— Check LED flashes on the Motor Control.</li> <li>— <b>See Motor Control Error Code list.</b></li> <li>— Connection Issue on Hall Effect sensor.</li> <li>— Fan wheel is not operating.</li> <li>— Hall sensor does not detect motor rotation.</li> </ul>
<b>E11</b>	Convection Temperature High	Excess oven temperature	<p>Convection Mode &amp; Combi Mode:</p> <ul style="list-style-type: none"> <li>— Convection Oven contactor(s) stuck closed.</li> <li>— N6 Oven Cavity Temperature probe defective.</li> <li>— N6 Cavity Probe connection problem.</li> <li>— Relay board, high voltage is not operating.</li> <li>— Wiring or connection issue.</li> </ul> <p>Combi Mode Only:</p> <ul style="list-style-type: none"> <li>— Insufficient water supply into oven for steam production.</li> </ul>

(CONTINUED ON NEXT PAGE)

# TROUBLESHOOTING

## CombiTouch ERROR CODES

Error Code	Error Call Out in Display	Description of Error	Possible Cause
<b>E13</b>	Boiler Temperature High	Boiler temperature overheats	<ul style="list-style-type: none"> <li>— Scale build up inside steam generator.</li> <li>— Scale build up on water level probe.</li> <li>— B4 Probe connection problem.</li> <li>— B4 probe faulty.</li> </ul>
<b>E15</b>	Condensor Temperature High	Excess condensor temperature	<ul style="list-style-type: none"> <li>— Untreated water supply line is shut off.</li> <li>— Untreated water supply line is connected to warm water.</li> <li>— B3 probe connection problem.</li> <li>— B3 probe is faulty.</li> <li>— Single solenoid valve Y2 obstructed or faulty.</li> <li>— Wiring or connection problem.</li> <li>— Relay board, high voltage is not operating.</li> </ul>
<b>E20</b>	<p>HACCP Only - B11 Core Temperature Probe Single Point Fault</p> <p>Error E20 is not shown in display. Instead a probe sign with “?” is shown as popup window. In case the customer cooks in time mode during first step and during second step switches to probe mode but has no probe in place, the error E20 will be shown in the error code list and HACCP list.</p>	Single point core temperature probe defect or disconnected.	<ul style="list-style-type: none"> <li>— Clean Probe Receptacle Pins with sand paper.</li> <li>— B11 Single Point Core Temperature probe with quick connect, defective.</li> <li>— B11 Single Point Core Temperature probe wires with quick connect, disconnected.</li> <li>— B11 Single Point Core Temperature probe receptacle, defective.</li> <li>— B11 Single Point Core Temperature probe receptacle wires disconnected.</li> </ul>
<b>E21</b>	N6 Cavity Probe Fault	Cavity temperature probe defect or disconnected	<ul style="list-style-type: none"> <li>— N6 Oven Cavity Temperature probe defective.</li> <li>— N6 Oven Cavity Temperature connection problem.</li> </ul>
<b>E22</b>	B10 Core Temperature Probe Multipoint Fault	Multipoint core temperature probe defect or disconnected	<ul style="list-style-type: none"> <li>— B10 Multipoint Core Temperature probe defective.</li> <li>— B10 Multipoint Core Temperature probe connection problem.</li> </ul>
<b>E23</b>	B4 Boiler Probe Fault	Boiler temperature probe defect or disconnected	<ul style="list-style-type: none"> <li>— B4 Boiler temperature probe defective.</li> <li>— B4 probe wires connection problem.</li> </ul>
<b>E24</b>	B5 Bypass Probe Fault	Bypass steam temperature probe defect or disconnected	<ul style="list-style-type: none"> <li>— B5 Bypass steam temperature probe defective.</li> <li>— B5 Bypass steam temperature connection problem.</li> </ul>
<b>E25</b>	B3 Condensor Probe Fault	Condensor water temperature probe defect or disconnected	<ul style="list-style-type: none"> <li>— B3 Condensor temperature probe defective.</li> <li>— B3 Condensor probe connection problem.</li> </ul>
<b>E26</b>	N8 Boiler Safety Temperature Probe Fault	Steam generator heating element protection probe defect or disconnected	<ul style="list-style-type: none"> <li>— N8 Boiler temperature probe defective.</li> <li>— N8 probe connection problem.</li> </ul>
<b>E27</b>	Boiler Element Temperature High	Excess steam generator safety probe	<ul style="list-style-type: none"> <li>— Scale build up inside steam generator.</li> <li>— Scale build up on water level probe.</li> <li>— Water level probe connection failure.</li> <li>— N8 boiler temperature probe defective.</li> <li>— N8 probe connection problem.</li> <li>— Steam element contactor(s) stuck closed.</li> <li>— Wiring or connection problem.</li> </ul>

(CONTINUED ON NEXT PAGE)



# TROUBLESHOOTING

## CombiTouch ERROR CODES

Error Code	Error Call Out in Display	Description of Error	Possible Cause
<b>E34</b>	Steam Generator Drain Pump Fault	Water level in steam generator does not drop during cleaning program	<ul style="list-style-type: none"> <li>— Scale build up inside the steam generator drain pump.</li> <li>— Scale build up inside the steam generator affecting water level probes.</li> <li>— Generator drain pump is faulty.</li> <li>— Connection issue at drain pump.</li> <li>— No output to pump from relay board.</li> </ul>
<b>E36</b>	Steam Temperature High	Oven cavity temperature is too high when operating in a steam mode or cleaning program	<ul style="list-style-type: none"> <li>— Water supply is shut off.</li> <li>— Low water pressure.</li> <li>— Wiring or connection issue.</li> <li>— Water injection pipe obstructed.</li> <li>— Water flow control valve plugged or defective.</li> <li>— Dual solenoid valve Y-1 obstructed or defective.</li> <li>— No output to solenoid valve form relay board.</li> </ul>
<b>E51</b>	No Water In Boiler	Water inside steam generator does not reach low water level	<ul style="list-style-type: none"> <li>— Water supply is shut off.</li> <li>— Low water pressure.</li> <li>— Generator drain cap missing or loose.</li> <li>— Generator drain pump is not sealing.</li> <li>— Generator drain pump elbow leaking.</li> <li>— Faulty or scaled water level probe.</li> <li>— Faulty or plugged dual solenoid valve assembly.</li> <li>— Wiring or connection issue.</li> <li>— No output to dual solenoid from relay board.</li> </ul>
<b>E53</b>	Fan Motor High Temperature	Fan motor too hot	<ul style="list-style-type: none"> <li>— Exhaust hood is not operating properly.</li> <li>— Check LED flashes on the Motor Control.</li> <li>— <b>See Motor Control Error Code list.</b></li> <li>— Connection Issue on Hall Effect sensor.</li> <li>— Fan wheel is not operating.</li> <li>— Hall sensor does not detect motor rotation.</li> </ul>
<b>E54</b>	Fan Motor 2 High Temperature	20*20 lower fan motor too hot	<ul style="list-style-type: none"> <li>— Exhaust hood is not operating properly.</li> <li>— Check LED flashes on the Motor Control.</li> <li>— <b>See Motor Control Error Code list.</b></li> <li>— Connection Issue on Hall Effect sensor.</li> <li>— Fan wheel is not operating.</li> <li>— Hall sensor does not detect motor rotation.</li> </ul>
<b>E55</b>	Vent Not Open	Browning valve does not open	<ul style="list-style-type: none"> <li>— Alignment issue between motor cam and vent motor safety switch (micro switch).</li> <li>— Fault vent valve (motor).</li> <li>— Fault vent valve safety switch (micro switch).</li> <li>— Wiring or connection problem.</li> </ul>

(CONTINUED ON NEXT PAGE)

# TROUBLESHOOTING

## CombiTouch ERROR CODES

<b>Error Code</b>	<b>Error Call Out in Display</b>	<b>Description of Error</b>	<b>Possible Cause</b>
<b>E57</b>	No Rinse Water	During rinse no water flow is detected through solenoid valve	<ul style="list-style-type: none"> <li>— Water supply is shut off.</li> <li>— Low water pressure.</li> <li>— Check wiring to all components mentioned below.</li> <li>— Flow switch is dirty or defective.</li> <li>— Dual water solenoid valve obstructed or faulty (Y3.)</li> <li>— Relay board, high voltage, defective.</li> </ul>
<b>E93</b>	Communication Error, FROM Display Board	Communication error between display board and low voltage relay board	<ul style="list-style-type: none"> <li>— Check ribbon cable connections mentioned below.</li> <li>— Ribbon cable defective.</li> <li>— Relay board, low voltage, connector defective.</li> <li>— Display board connector defective.</li> </ul>
<b>E94</b>	Communication Error, TO Display Board	Communication error between display board and low voltage relay board	<ul style="list-style-type: none"> <li>— Check ribbon cable connections mentioned below.</li> <li>— Ribbon cable defective.</li> <li>— Relay board, low voltage, connector defective.</li> <li>— Display board connector defective.</li> </ul>
<b>E98</b>	RB is in Cesium and DB is in Fahrenheit	Conflict of unit configuration in the setup menu	<ul style="list-style-type: none"> <li>— Relay board and Data board do not match, use setup menu to change format.</li> </ul>
<b>E99</b>	RB is in Fahrenheit and DB is in Cesium	Conflict of unit configuration in the setup menu	<ul style="list-style-type: none"> <li>— Relay board and Data board do not match, use setup menu to change format.</li> </ul>
<b>E100</b>	DB is not equal to RB version. Error generated by DB.	Software update may have failed.	<ul style="list-style-type: none"> <li>— Check ribbon cable connections.</li> <li>— Ribbon cable defective.</li> <li>— Relay board, low voltage, connector defective.</li> <li>— Display board connector defective.</li> <li>— Software may need to be updated again.</li> </ul>
<b>E101</b>	DB is not equal to RB version. Error generated by RB.	Software update may have failed.	<ul style="list-style-type: none"> <li>— Check ribbon cable connections.</li> <li>— Ribbon cable defective.</li> <li>— Relay board, low voltage, connector defective.</li> <li>— Display board connector defective.</li> <li>— Software may need to be updated again.</li> </ul>

(SEE MOTOR CONTROL ERROR CHART ON NEXT PAGE)

# TROUBLESHOOTING

## CombiTouch MOTOR CONTROL ERROR CODES

Type of Error	Indication	Release of Error
Undervoltage	LED flashing sequence, with 1 flash per period.	Voltage of intermediate circuit is less than 250V
Overvoltage	LED flashing sequence, with 2 flashes per period.	Voltage of intermediate circuit exceeds 445V
Excess Temperature	LED flashing sequence, with 3 flashes per period.	Temperature sensor in the power unit is more than 93°C
Overcurrent	LED flashing sequence, with 4 flashes per period.	Blocked motor, detected by current peak monitoring from 900 rpm rotating field
Overcurrent	LED flashing sequence, with 5 flashes per period.	Intermediate circuit current exceeds 4.0A
Short-circuit	LED flashing sequence, with 6 flashes per period.	Release of interrupt at intermediate circuit current larger than 53A
Power on	LED flashing sequence, with 7 flashes per period.	Effective mains voltage does not correspond to jumper setting 115V/230V
Watchdog	LED flashing sequence, with 8 flashes per period.	Watchdog of the microcontroller released, program crash